

SULLY, ONYX WEISS

U1S-TWT3H1

Traditionell, Handtuchwärmer, Warmwasser, 1 kollektionsspezifischer Bedienungsriff, 3 Stangen, 625 mm x 575 mm

THG[®]
PARIS

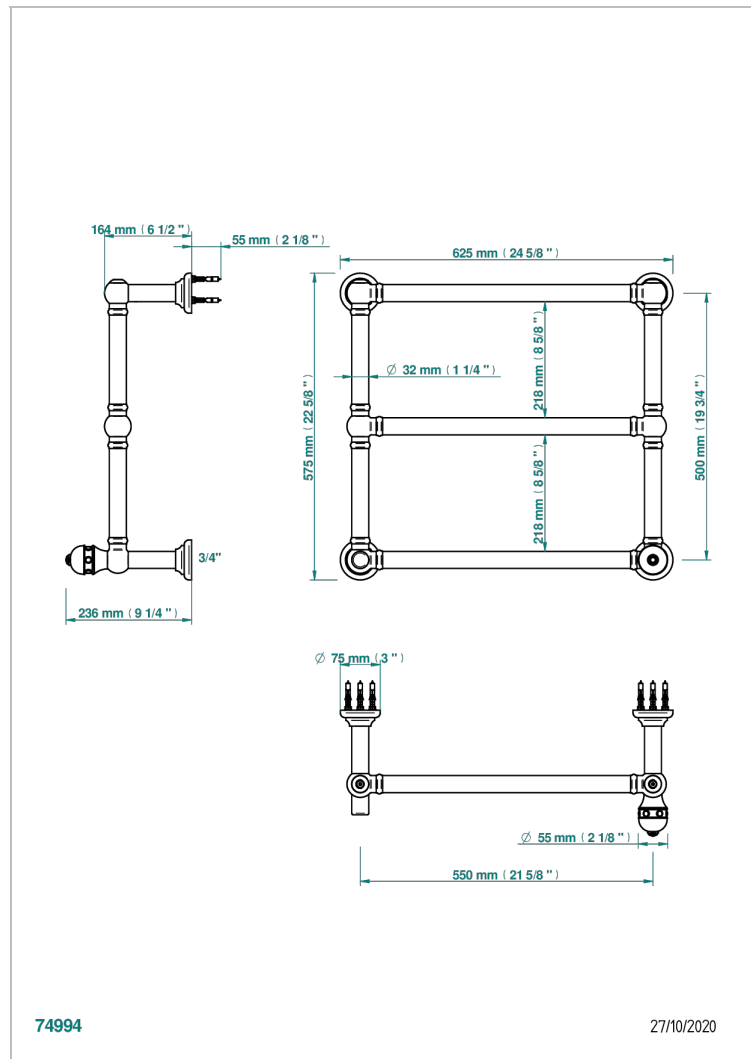

74994

27/10/2020

EIGENSCHAFTEN

- Sully, Onyx Weiß
- Traditionell, Handtuchwärmer, Warmwasser, 1 kollektionsspezifischer Bedienungsriff, 3 Stangen, 625 mm x 575 mm

TECHNISCHE DATEN

- Pression : 0,5 bars < P < 3 bars (recommandée)
- Pressure : 7.25 psi < P < 43.5 psi (advised)
- Température eau maximale conseillée : 60°C
- Maximum water temperature advised: 140°F
- Hauteur minimale au sol (maximum height from the ground) : 60 cm (24")
- Puissance / Power : 64W à Delta T 30

VERFÜGBARE OBERFLÄCHEN

Blassgold - F30
Blassgold matt unlackiert - F31
Bronze hell - D01
Chrom - A02
Chrom matt - C02
Gold - F01

Gold matt - F07
Nickel matt - C01
Pvd blush - H62
Pvd blush matt - H60
Pvd bronze braun - F33
Pvd bronze braun matt - F34

Pvd gold - H52
Pvd gold matt - H53
Pvd graphite - H64
Pvd graphite matt - H65
Pvd messing - H49
Pvd messing matt - H50

Pvd nickel - H55
Pvd nickel matt - H56
Pvd umber - H66
Pvd umber matt - H67
Silbernickel - B01