

# VOGUE LAPIS LAZULI

A8S-TWT3H2

Traditional towel warmer, 3 rails, 625 mm x 575 mm, hydronic with 2 stylised handles

THG<sup>®</sup>  
PARIS

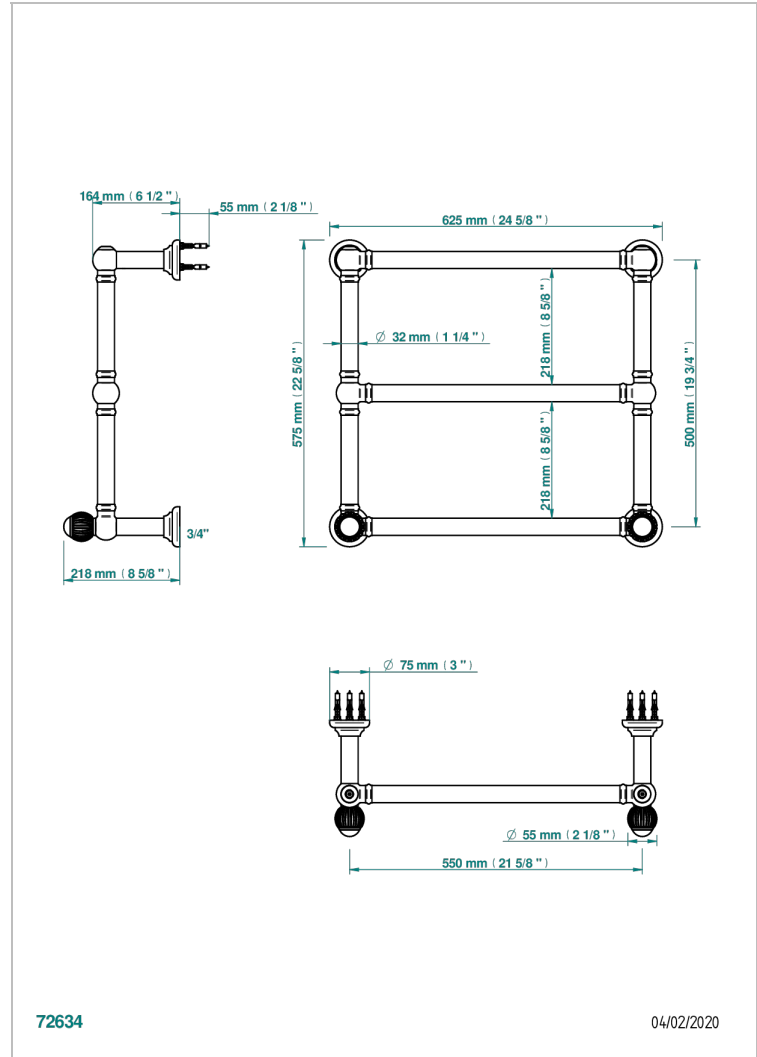

72634

04/02/2020

## CHARACTERISTIC

- Vogue Lapis Lazuli
- Traditional towel warmer, 3 rails, 625 mm x 575 mm, hydronic with 2 stylised handles

## TECHNICAL SPECS

- Pression : 0,5 bars < P < 3 bars (recommandée)
- Pressure : 7.25 psi < P < 43.5 psi (advised)
- Température eau maximale conseillée : 60°C
- Maximum water temperature advised: 140°F
- Hauteur minimale au sol (maximum height from the ground) : 60 cm (24")
- Puissance / Power : 64W à Delta T 30

## AVAILABLE FINITIONS

Blush PVD - H62  
Brass color PVD - H49  
Brown bronze color PVD - F33  
Gold color PVD - H52  
Graphite PVD - H64  
Lacquered light bronze - D01

Matt Umber PVD - H67  
Matt blush PVD - H60  
Matt brass color PVD - H50  
Matt brown bronze color PVD - F34  
Matt chrome - C02  
Matt gold - F07

Matt gold color PVD - H53  
Matt graphite PVD - H65  
Matt nickel (color finish) - C01  
Matt nickel color PVD - H56  
Nickel color PVD - H55  
Polished chrome (color finish) - A02

Polished gold (color finish) - F01  
Polished nickel - B01  
Soft gold - F30  
Soft matt gold - F31  
Umber PVD - H66