

# MONTE CARLO, GOLD PORCELAIN

U8B-TWF4H1

传统式凹槽毛巾散热器，4杆，625 mm x 825 mm，液压，带1个有款式的角阀

THG<sup>®</sup>  
PARIS

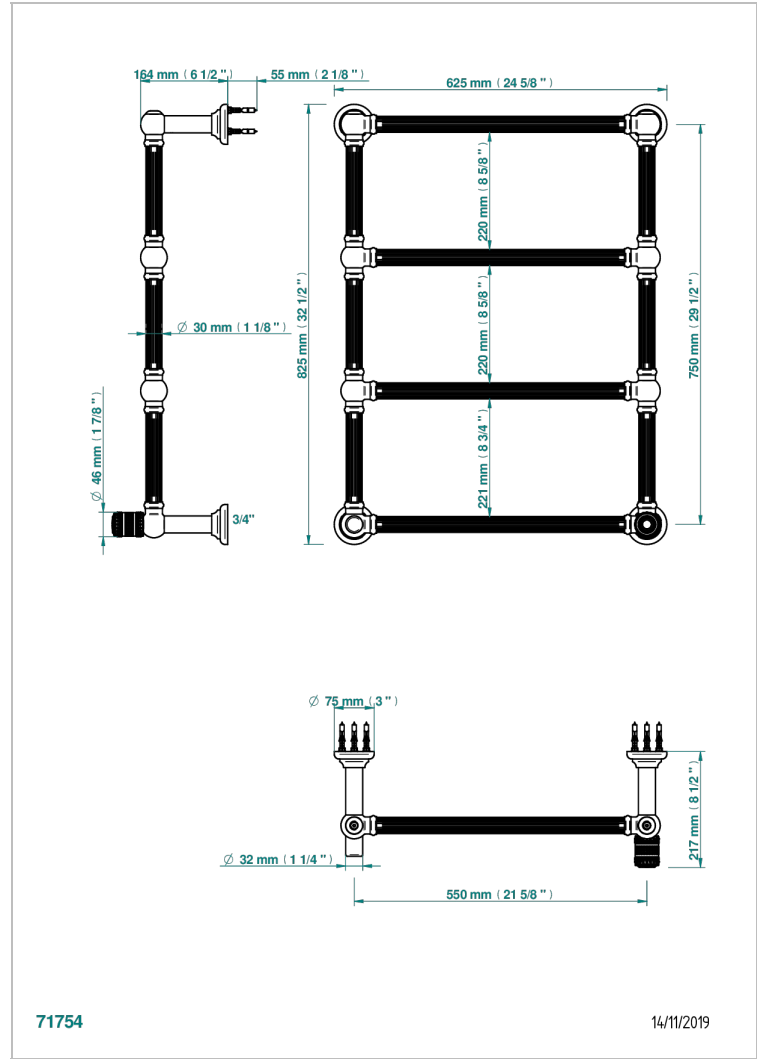

71754

14/11/2019

## 特色

- Monte Carlo, gold porcelain
- 传统式凹槽毛巾散热器，4杆，625 mm x 825 mm，液压，带1个有款式的角阀

## 技术特征

- Pression : 0,5 bars < P < 3 bars (recommandée)
- Pressure : 7.25 psi < P < 43.5 psi (advised)
- Température eau maximale conseillée : 60°C
- Maximum water temperature advised: 140°F
- Hauteur minimale au sol (maximum height from the ground) : 60 cm (24")
- Puissance / Power : 86W à Delta T 30

## 可选饰面

Blush PVD - H62  
Graphite PVD - H64  
Matt Umber PVD - H67  
Matt blush PVD - H60  
Matt graphite PVD - H65  
PVD哑光棕铜 - F34

PVD哑光金 - H53  
PVD哑光铜 - H50  
PVD哑光镍 - H56  
PVD抛光铜 - H49  
PVD棕铜 - F33  
PVD金色 - H52

PVD镍 - H55  
Umber PVD - H66  
哑光浅金 - F31  
哑光金 - F07  
哑光铬 - C02  
哑光镍 - C01

抛光金 (24K金) - F01  
抛光铬 - A02  
抛光镍 - B01  
浅金 - F30  
漆面铜 - D01