

MALMAISON PORTORO

U95-TWF3H1

Traditional towel warmer with fluted tube, 3 rails, 625 mm x 575 mm, hydronic with 1 stylised handle

THG[®]
PARIS

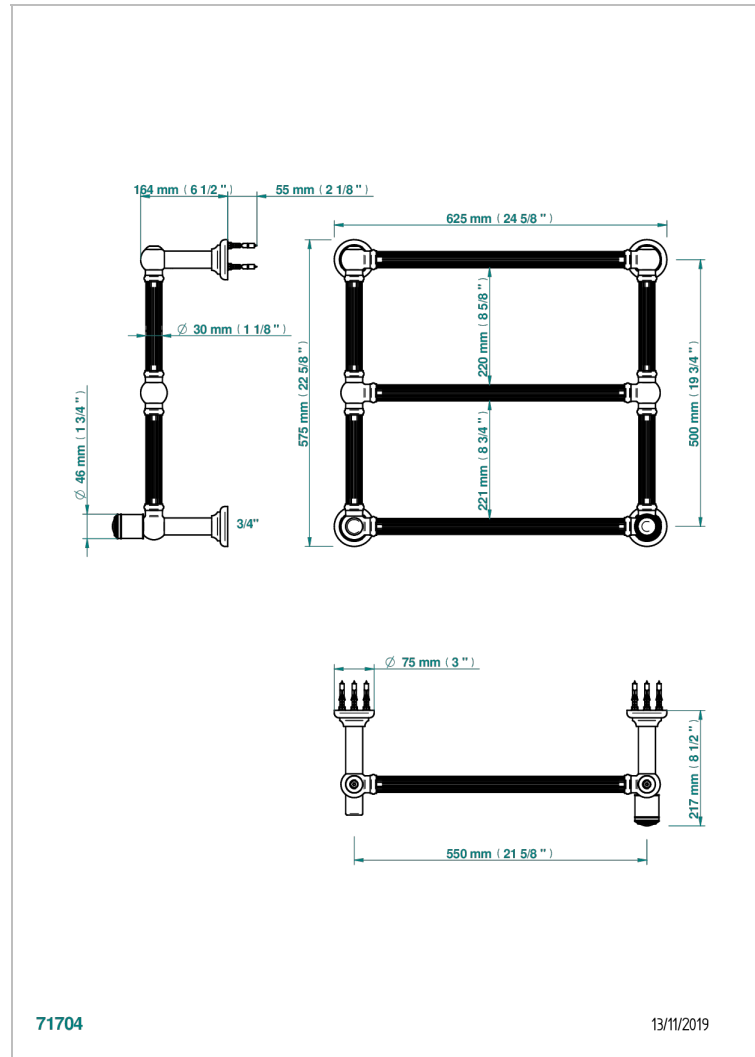

CHARACTERISTIC

- Malmaison Portoro
- Traditional towel warmer with fluted tube, 3 rails, 625 mm x 575 mm, hydronic with 1 stylised handle

TECHNICAL SPECS

- Pression : 0,5 bars < P < 3 bars (recommandée)
- Pressure : 7.25 psi < P < 43.5 psi (advised)
- Température eau maximale conseillée : 60°C
- Maximum water temperature advised: 140°F
- Hauteur minimale au sol (maximum height from the ground) : 60 cm (24")
- Puissance / Power : 64W à Delta T 30

AVAILABLE FINITIONS

Lacquered light bronze - D01
Matt chrome - C02
Matt gold - F07
Matt nickel (color finish) - C01
Polished chrome (color finish) - A02
Polished gold (color finish) - F01

Polished nickel - B01
Soft gold - F30
Soft matt gold - F31