

Traditional towel warmer with fluted tube, 3 rails, 625 mm x 575 mm, hydronic with 1 stylised handle

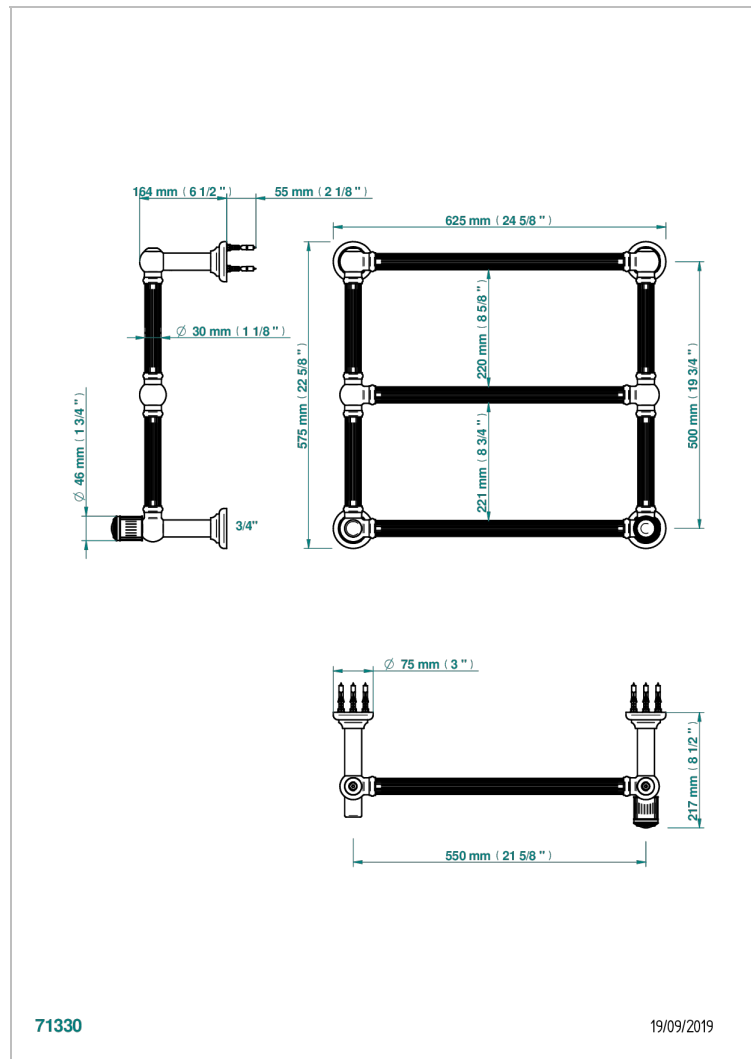

### CHARACTERISTIC

- Malmaison Metal
- Traditional towel warmer with fluted tube, 3 rails, 625 mm x 575 mm, hydronic with 1 stylised handle

### TECHNICAL SPECS

- Pression : 0,5 bars < P < 3 bars (recommandée)
- Pressure : 7.25 psi < P < 43.5 psi (advised)
- Température eau maximale conseillée : 60°C
- Maximum water temperature advised: 140°F
- Hauteur minimale au sol (maximum height from the ground) : 60 cm (24")
- Puissance / Power : 64W à Delta T 30

### AVAILABLE FINITIONS

- Lacquered light bronze - D01
- Matt chrome - C02
- Matt gold - F07
- Matt nickel (color finish) - C01
- Polished chrome (color finish) - A02
- Polished gold (color finish) - F01

- Polished nickel - B01
- Soft gold - F30
- Soft matt gold - F31