

# TOWEL WARMER - TRADITIONAL

B6A-TWF4H

Traditional towel warmer with fluted tube, 4 rails, 625 mm x 825 mm, hydronic, neutral handle

THG<sup>®</sup>  
PARIS

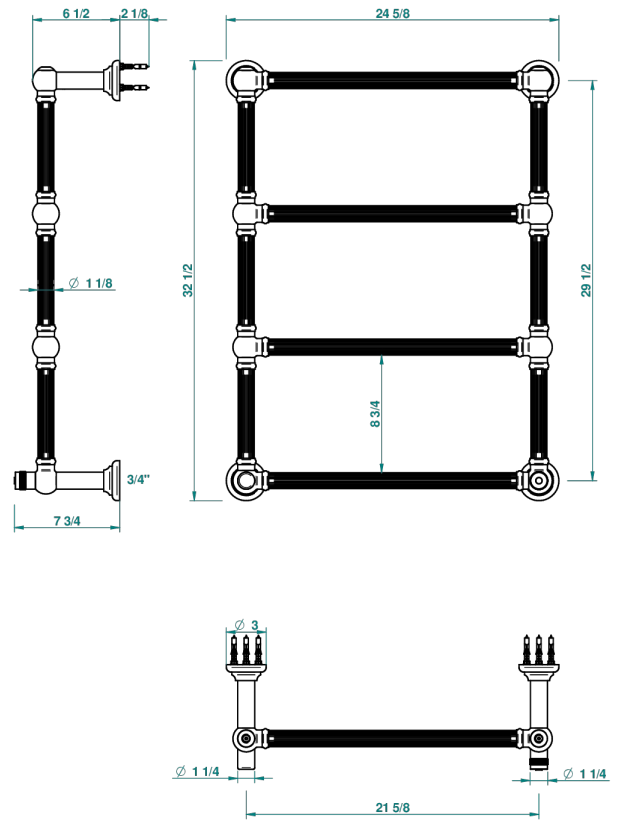
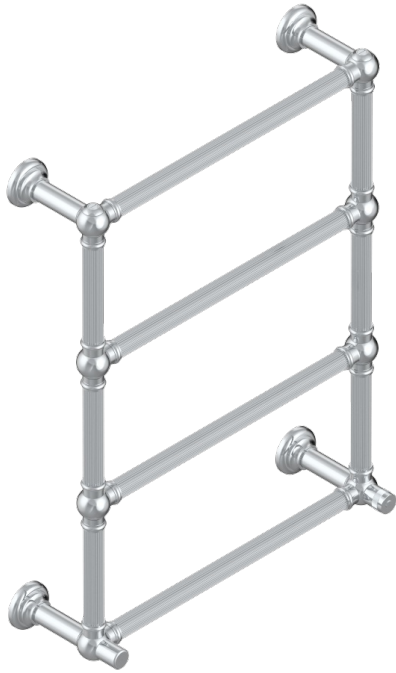

70231

02/05/2019

## CARACTERÍSTICAS

- Cuerpo en latón macizo
- Conexiones en F3/4"

## ESPECIFICACIONES TÉCNICAS

- Pression : 0,5 bars < P < 3 bars (recommandée)
- Pressure : 7.25 psi < P < 43.5 psi (advised)
- Température eau maximale conseillée : 60°C
- Maximum water temperature advised: 140°F
- Hauteur minimale au sol (maximum height from the ground) : 60 cm (24")
- Puissance / Power : 86W à Delta T 30

## ACABADOS DISPONIBLES

Bronce claro - D01  
Cromo - A02  
Cromo mate - C02  
Dorado - F01  
Dorado mate - F07  
Dorado pálido - F30

Dorado pálido mate (sin barniz) - F31  
Níquel - B01  
Níquel mate - C01  
Pvd blush - H62  
Pvd blush mate - H60  
Pvd color latón - H49

Pvd color latón mate - H50  
Pvd color níquel - H55  
Pvd color níquel mate - H56  
Pvd color oro - H52  
Pvd color oro mate - H53  
Pvd grafito - H64

Pvd grafito mate - H65  
Pvd umber - H66  
Pvd umber mate - H67