

GRAND CENTRAL METAL

U9K-TWF4H2

传统式凹槽毛巾散热器，4杆，625 mm x 825 mm，液压，带2个有款式的角阀

THG[®]
PARIS

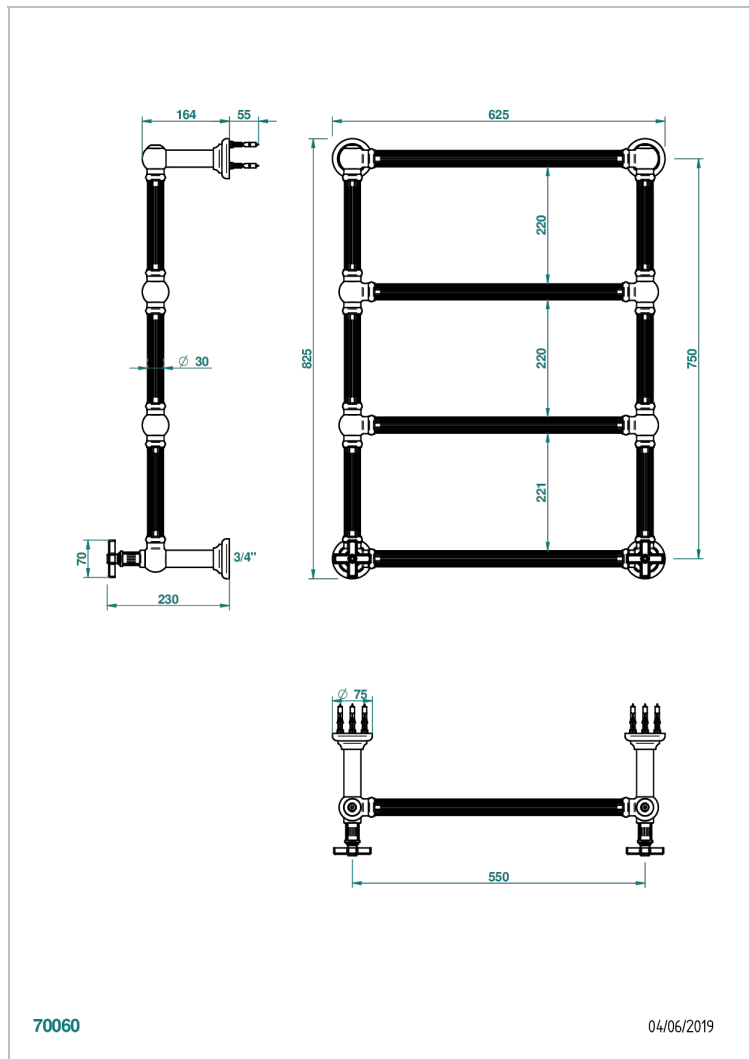

特色

- Grand central Metal
- 传统式凹槽毛巾散热器，4杆，625 mm x 825 mm，液压，带2个有款式的角阀

技术特征

- Pression : 0,5 bars < P < 3 bars (recommandée)
- Pressure : 7.25 psi < P < 43.5 psi (advised)
- Température eau maximale conseillée : 60°C
- Maximum water temperature advised: 140°F
- Hauteur minimale au sol (maximum height from the ground) : 60 cm (24")
- Puissance / Power : 86W à Delta T 30

可选饰面

Blush PVD - H62
Graphite PVD - H64
Matt Umber PVD - H67
Matt blush PVD - H60
Matt graphite PVD - H65
PVD哑光棕铜 - F34

PVD哑光金 - H53
PVD哑光铜 - H50
PVD哑光镍 - H56
PVD抛光铜 - H49
PVD棕铜 - F33
PVD金色 - H52

PVD镍 - H55
Umber PVD - H66
哑光浅金 - F31
哑光金 - F07
哑光铬 - C02
哑光镍 - C01

抛光金 (24K金) - F01
抛光铬 - A02
抛光镍 - B01
浅金 - F30
漆面铜 - D01