

TOWEL WARMER - TRADITIONAL

B6A-TWT3E

Traditional towel warmer, 3 rails, 625 mm x 575 mm, electric

THG[®]
PARIS

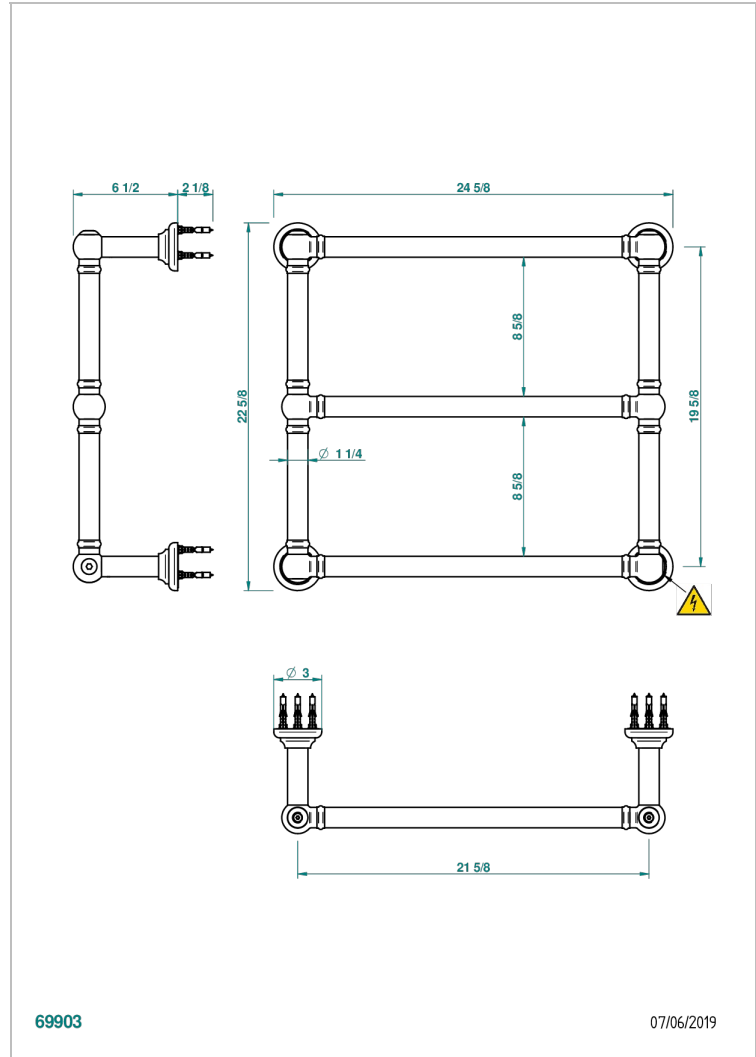
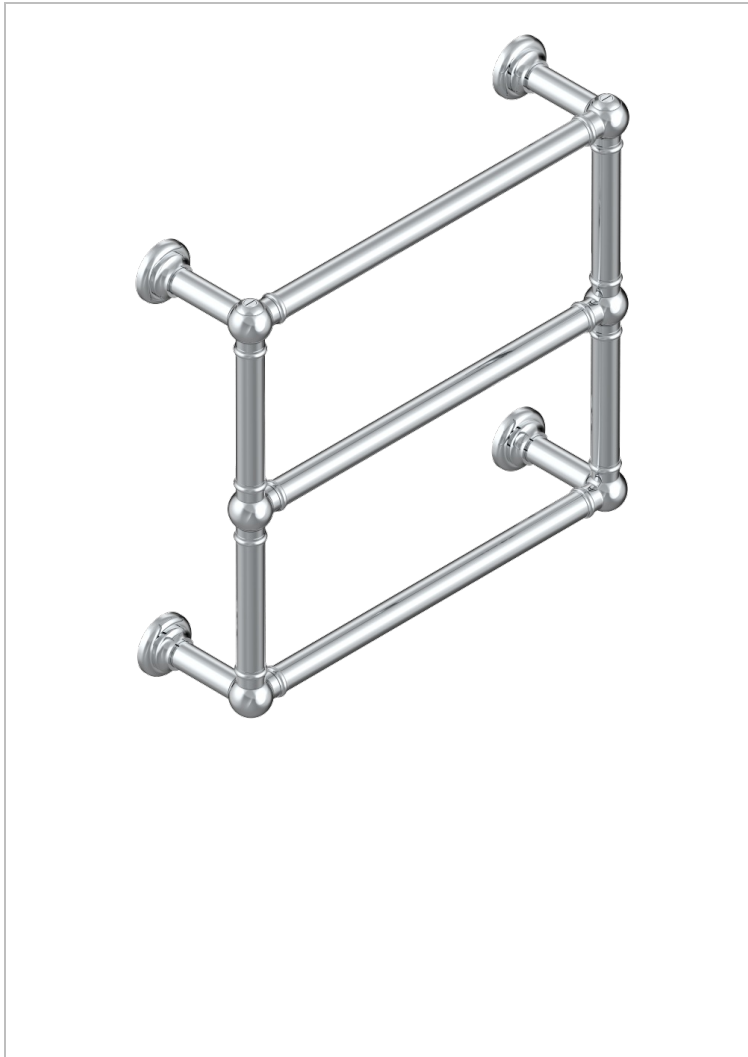

69903

07/06/2019

CHARACTERISTIC

- Solid brass body, seamless
- Resistance with thermal auto-regulation
- Installation possible with a wall mounted electric switch or timer (not supplied)
- Non-toxic and recyclable heat transfer fluid
- Hidden wire - standard length 1.20 m - Option 5 m (Class I only) - ref. TWCA5

TECHNICAL SPECS

- Tension (voltage) : 110V ou 230V
- Puissance (power) : 70W
- IPX4
- CE classe 1, 2
- Hauteur minimale au sol (minimum height from the ground) : 60 cm (24")
- Température maximale (maximum temperature) : 60°C (140°F)

AVAILABLE FINITIONS

Blush PVD - H62
Brass color PVD - H49
Gold color PVD - H52
Graphite PVD - H64
Lacquered light bronze - D01
Matt Umber PVD - H67

Matt blush PVD - H60
Matt brass color PVD - H50
Matt chrome - C02
Matt gold - F07
Matt gold color PVD - H53
Matt graphite PVD - H65

Matt nickel (color finish) - C01
Matt nickel color PVD - H56
Nickel color PVD - H55
Polished chrome (color finish) - A02
Polished gold (color finish) - F01
Polished nickel - B01

Soft gold - F30
Soft matt gold - F31
Umber PVD - H66