

# PROFIL METAL

A6A-TWS4H2

Contemporary square towel warmer, 4 rails, 520 mm x 510 mm, hydronic with 2 stylised handles

THG<sup>®</sup>  
PARIS

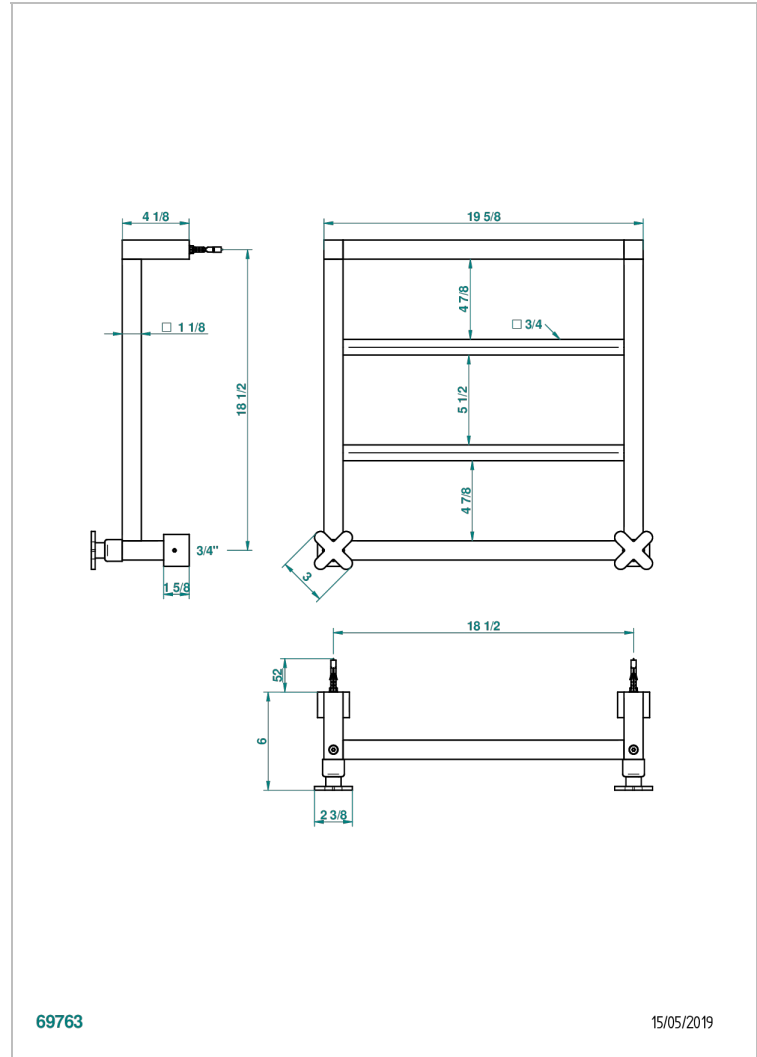

69763

15/05/2019

## CHARACTERISTIC

- Solid brass body seamless
- 2 x 1/2" normal head
- Connections F3/4"

## TECHNICAL SPECS

- Pression : 0,5 bars < P < 3 bars (recommandée)
- Pressure : 7.25 psi < P < 43.5 psi (advised)
- Température eau maximale conseillée : 60°C
- Maximum water temperature advised: 140°F
- Hauteur minimale au sol (maximum height from the ground) : 60 cm (24")
- Puissance / Power : 64W à Delta T 30

## AVAILABLE FINITIONS

Blush PVD - H62  
Brass color PVD - H49  
Brown bronze color PVD - F33  
Gold color PVD - H52  
Graphite PVD - H64  
Matt Umber PVD - H67

Matt blush PVD - H60  
Matt brass color PVD - H50  
Matt brown bronze color PVD - F34  
Matt chrome - C02  
Matt gold - F07  
Matt gold color PVD - H53

Matt graphite PVD - H65  
Matt nickel (color finish) - C01  
Matt nickel color PVD - H56  
Nickel color PVD - H55  
Polished chrome (color finish) - A02  
Polished gold (color finish) - F01

Polished nickel - B01  
Soft gold - F30  
Soft matt gold - F31  
Umber PVD - H66