

TOWEL WARMER - CONTEMPORARY

B6B-TWS4H

现代式方形毛巾散热器，4杆，520 mm x 510 mm，液压，普通角阀

THG[®]
PARIS

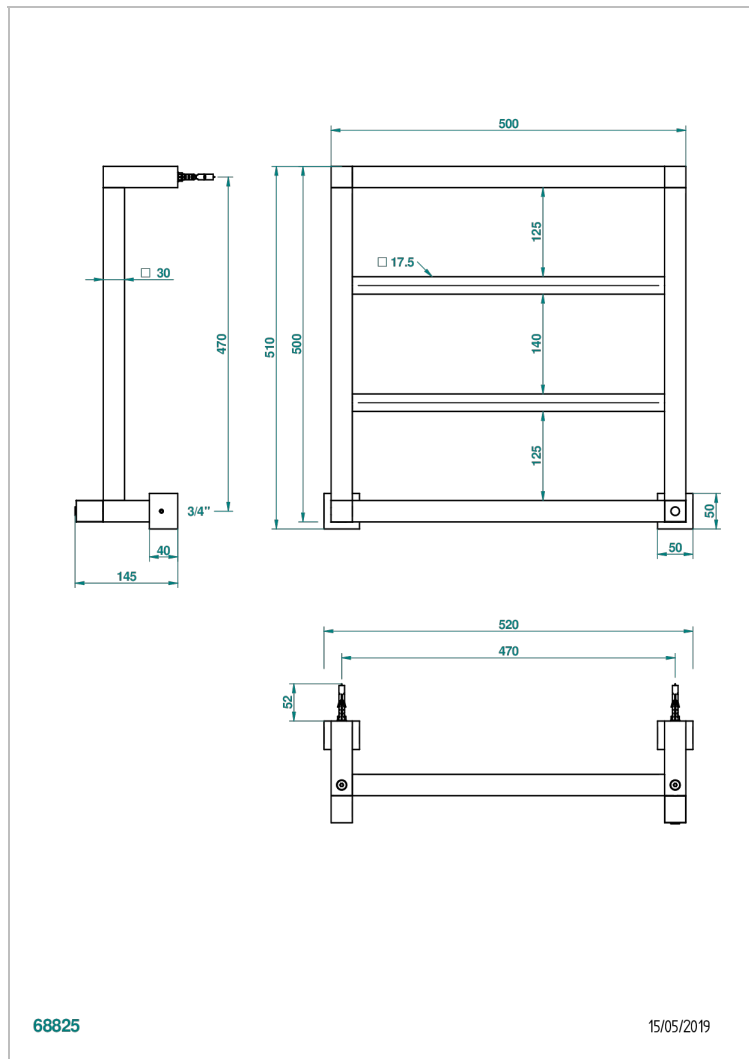

特色

- Towel Warmer - Contemporary
- 现代式方形毛巾散热器，4杆，520 mm x 510 mm，液压，普通角阀

技术特征

- Pression : 0,5 bars < P < 3 bars (recommandée)
- Pressure : 7.25 psi < P < 43.5 psi (advised)
- Température eau maximale conseillée : 60°C
- Maximum water temperature advised: 140°F
- Hauteur minimale au sol (maximum height from the ground) : 60 cm (24")
- Puissance / Power : 64W à Delta T 30

可选饰面

Blush PVD - H62
Graphite PVD - H64
Matt Umber PVD - H67
Matt blush PVD - H60
Matt graphite PVD - H65
PVD哑光金 - H53

PVD哑光铜 - H50
PVD哑光镍 - H56
PVD抛光铜 - H49
PVD金色 - H52
PVD镍 - H55
Umber PVD - H66

哑光浅金 - F31
哑光金 - F07
哑光铬 - C02
哑光镍 - C01
抛光金 (24K金) - F01
抛光铬 - AO2

抛光镍 - B01
浅金 - F30