

# TOWEL WARMER - CONTEMPORARY

B6B-TWS4H

现代式方形毛巾散热器，4杆，520 mm x 510 mm，液压，普通角阀

THG<sup>®</sup>  
PARIS

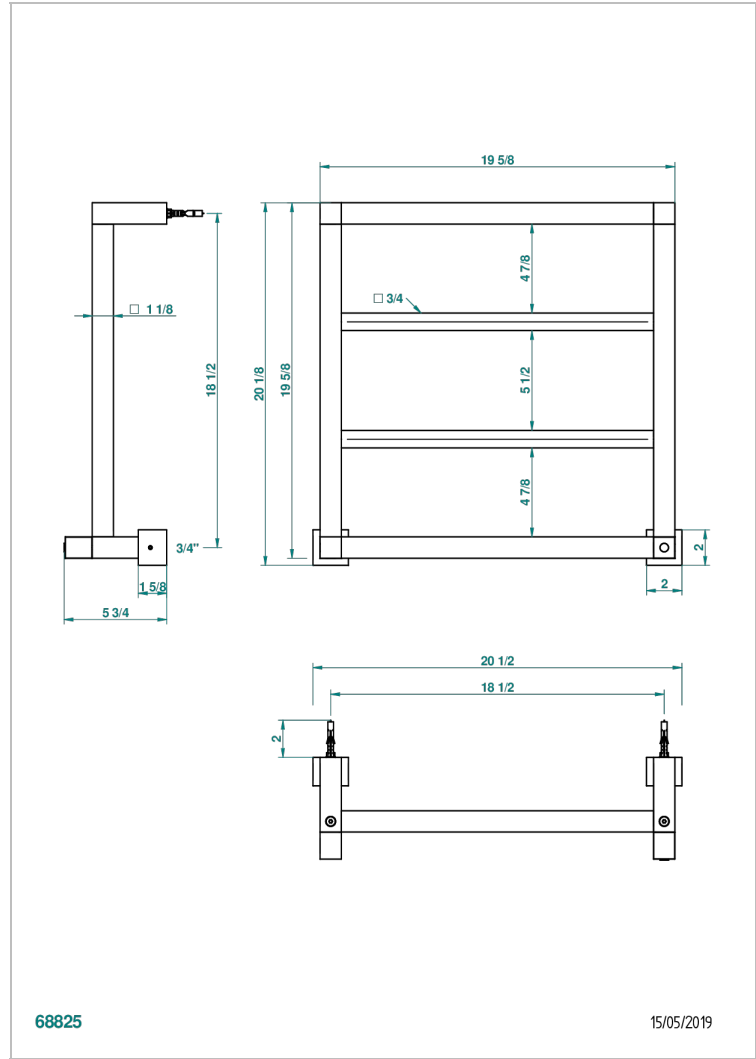

## 特色

- Towel Warmer - Contemporary
- 现代式方形毛巾散热器，4杆，520 mm x 510 mm，液压，普通角阀

## 技术特征

- Pression : 0,5 bars < P < 3 bars (recommandée)
- Pressure : 7.25 psi < P < 43.5 psi (advised)
- Température eau maximale conseillée : 60°C
- Maximum water temperature advised: 140°F
- Hauteur minimale au sol (maximum height from the ground) : 60 cm (24")
- Puissance / Power : 64W à Delta T 30

## 可选饰面

Blush PVD - H62  
Graphite PVD - H64  
Matt Umber PVD - H67  
Matt blush PVD - H60  
Matt graphite PVD - H65  
PVD哑光金 - H53

PVD哑光铜 - H50  
PVD哑光镍 - H56  
PVD抛光铜 - H49  
PVD金色 - H52  
PVD镍 - H55  
Umber PVD - H66

哑光浅金 - F31  
哑光金 - F07  
哑光铬 - C02  
哑光镍 - C01  
抛光金 (24K金) - F01  
抛光铬 - AO2

抛光镍 - B01  
浅金 - F30