

GRAND CENTRAL WHITE ONYX WITH LEVER HANDLES

U9S-36/C

Einbauventil zur Standmontage 3/4", Kalt

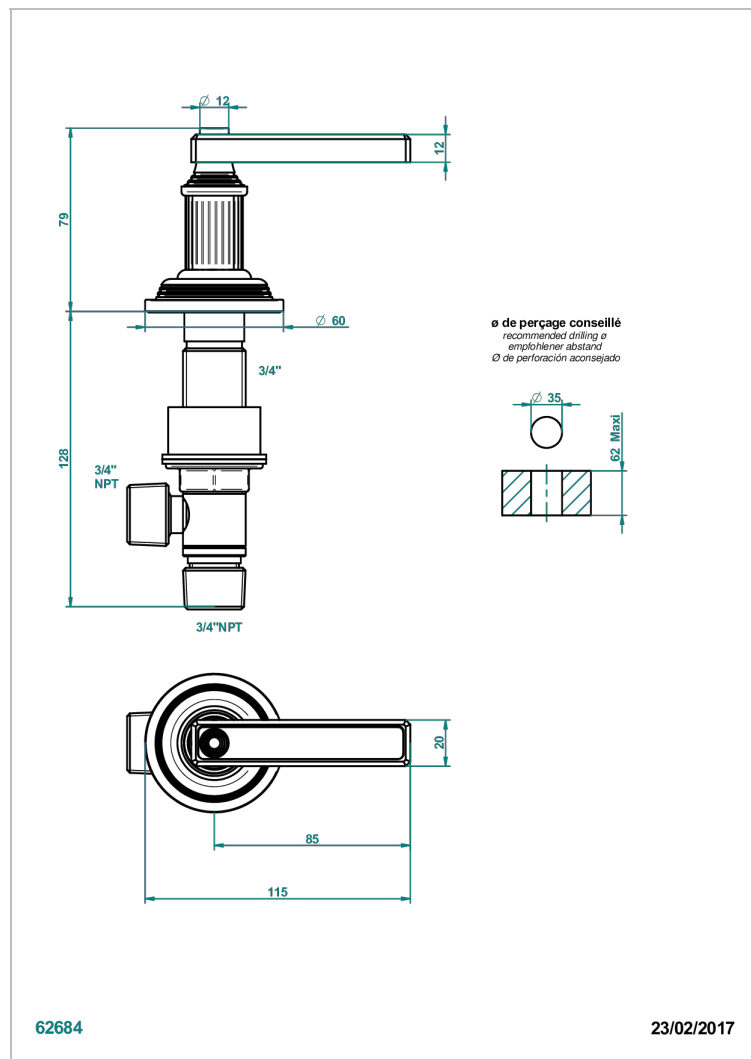

EIGENSCHAFTEN

- Grand central White Onyx with lever handles
- Einbauventil zur Standmontage 3/4", Kalt

VERFÜGBARE OBERFLÄCHEN

Altnickel - H28
Blassgold - F30
Blassgold matt unlackiert - F31
Bronze hell - D01
Chrom - A02
Chrom matt - C02

Gold - F01
Gold matt - F07
Kupfer altrot matt lackiert - H07
Mattschwarz keramik - D30
Natural smoked Brass - A13
Nickel matt - C01

Pvd blush - H62
Pvd blush matt - H60
Pvd bronze braun - F33
Pvd bronze braun matt - F34
Pvd gold - H52
Pvd gold matt - H53

Pvd graphite - H64
Pvd graphite matt - H65
Pvd messing - H49
Pvd messing matt - H50
Pvd nickel - H55
Pvd nickel matt - H56

Pvd umber - H66
Pvd umber matt - H67
Silbernichel - B01