

# GRAND CENTRAL WHITE ONYX WITH LEVER HANDLES

U9S-36/C

Einbauventil zur Standmontage 3/4", Kalt

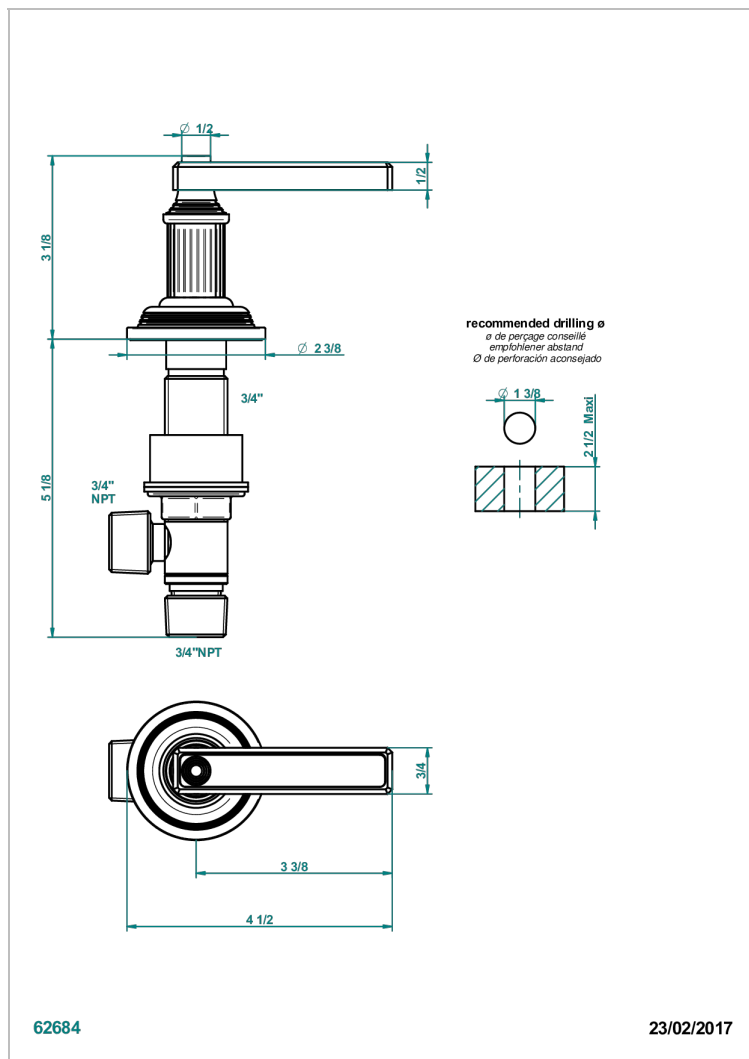

## EIGENSCHAFTEN

- Grand central White Onyx with lever handles
- Einbauventil zur Standmontage 3/4", Kalt

## VERFÜGBARE OBERFLÄCHEN

Altnickel - H28  
Blassgold - F30  
Blassgold matt unlackiert - F31  
Bronze hell - D01  
Chrom - A02  
Chrom matt - C02

Gold - F01  
Gold matt - F07  
Kupfer altrot matt lackiert - H07  
Mattschwarz keramik - D30  
Natural smoked Brass - A13  
Nickel matt - C01

Pvd blush - H62  
Pvd blush matt - H60  
Pvd bronze braun - F33  
Pvd bronze braun matt - F34  
Pvd gold - H52  
Pvd gold matt - H53

Pvd graphite - H64  
Pvd graphite matt - H65  
Pvd messing - H49  
Pvd messing matt - H50  
Pvd nickel - H55  
Pvd nickel matt - H56

Pvd umber - H66  
Pvd umber matt - H67  
Silbernickel - B01