

# WEST COAST WHITE ONYX WITH LEVER HANDLES

U9H-520/60

Single towel rail, fixed rail, length: 600 mm, ø 20 mm

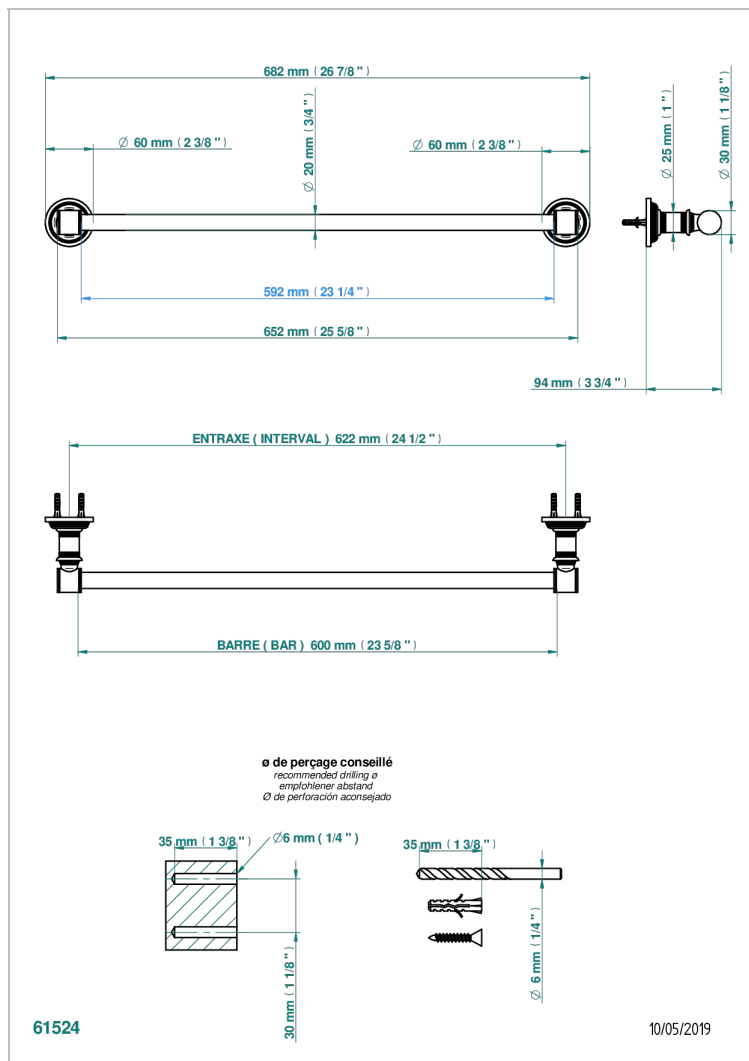

## CHARACTERISTIC

- West Coast White Onyx with lever handles
- Single towel rail, fixed rail, length: 600 mm, ø 20 mm

## AVAILABLE FINITIONS

Antique nickel - H28  
Black ceram - D30  
Blush PVD - H62  
Brass color PVD - H49  
Brown bronze color PVD - F33  
Gold color PVD - H52

Graphite PVD - H64  
Lacquered light bronze - D01  
Matt Umber PVD - H67  
Matt blush PVD - H60  
Matt brass color PVD - H50  
Matt brown bronze color PVD - F34

Matt chrome - C02  
Matt gold - F07  
Matt gold color PVD - H53  
Matt graphite PVD - H65  
Matt nickel (color finish) - C01  
Matt nickel color PVD - H56

Natural smoked Brass - A13  
Nickel color PVD - H55  
Polished chrome (color finish) - A02  
Polished gold (color finish) - F01  
Polished nickel - B01  
Soft gold - F30

Soft matt gold - F31  
Umber PVD - H66  
Varnished matt antique red copper (color finish) - H07