

Compatible with

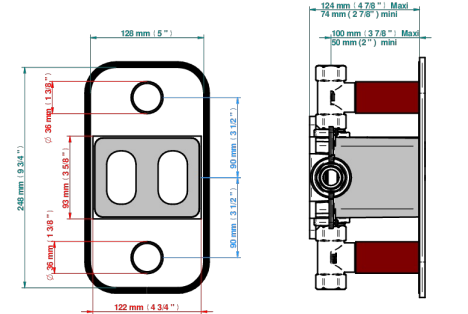

5400AE  
5400AE/US  
5400AE/W



Boîte / Box Joint Plaque / Seal Plate Tube

59173

09/06/2022

### CHARACTERISTIC

- Built-in thermostatic cover for 5400AE - 5400AE/W - 5400AE/US with 2 no. 3/4" outputs
- Requires concealed thermostat réf 5400AE - 5400AE/W - 5400AE/US
- For shower 2 simultaneous functions
- Temperature control knob with security stop at 38°C
- Solid brass plate and knob
- ASME : ASME A112.18.1-2011/CSA B125.1-11
- DVGW : DW-6512CQ0608

### STANDARDS



### RELATED SKU'S

- Ref. G00-5400AE/US 3/4" THG thermostat with wax cartridge, with two valves delivered with a built-in box, no trim
- Ref. G00-5100G Reinforced stop ring for THG thermostatic with fixing set

### AVAILABLE FINITIONS

Black ceram - D30  
 Chrome polished - A02  
 Chrome polished / gold polished - G02  
 Gold mat - F07  
 Gold polished - F01  
 Matt chrome (American satin) - C02

Matt nickel (American satin) - C01  
 Nickel antique / Sovereign - H28  
 Nickel polished - B01  
 Soft gold - F30  
 Soft matt gold - F31