

Trim for THG thermostat 3 functions , with one off function and 2 outlets and one single off function - rough part supplied with fixing box ref. 5 540AE/US

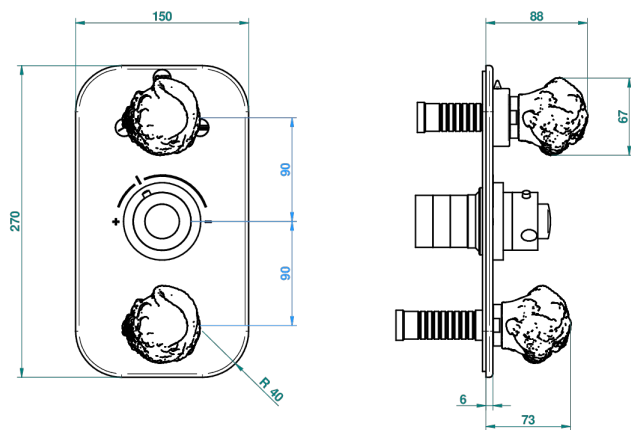

3 pastilles inclus / 3 pads included



Compatible with



5540AE
5540AE/US
5540AE/W

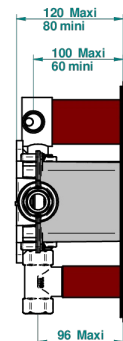
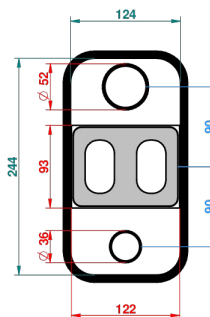

Boite / Box Joint Plaque / Seal Plate Tube

58147

09/01/2019

CHARACTERISTIC

- Built-in thermostatic cover for 5540AE with 3 outputs (1 x 3/4' and 2 x 1/2')
- Requires concealed thermostat Réf. 5540AE - 5540AE/US - 5540AE/W
- Output high : ceramic diverter with 2 functions and stopvalve
- Output downwards : 1/4' turn of 3/4' stopvalve
- For Shower 3 functions - 2 functions can operate simultaneously
- Temperature control knob with security stop at 38°C
- Solid brass plate and knob
- ASME : ASME A112.18.1-2011/CSA B125.1-11
- DVGW : DW-6512CQ0608

STANDARDS



RELATED SKU'S

- Ref. G00-5100G Reinforced stop ring for THG thermostatic with fixing set
- Ref. G00-5540AE/US Thg thermostat with wax cartridge with one stop valve, 2 outlets and another stop valve, delivered with a built-in box, no trim

AVAILABLE FINITIONS

Black ceram - D30
Blush PVD - H62
Brass color PVD - H49
Brown bronze color PVD - F33
Chrome polished - A02
Chrome polished / gold polished - G02

Copper antique matt, coated - H07
Gold color PVD - H52
Gold mat - F07
Gold polished - F01
Graphite PVD - H64
Light coated bronze - D01

Matt Umber PVD - H67
Matt blush PVD - H60
Matt brass color PVD - H50
Matt brown bronze color PVD - F34
Matt chrome (American satin) - C02
Matt gold color PVD - H53

Matt graphite PVD - H65
Matt nickel (American satin) - C01
Matt nickel color PVD - H56
Nickel antique / Sovereign - H28
Nickel color PVD - H55
Nickel polished - B01

Soft gold - F30
Soft matt gold - F31
Umber PVD - H66