

SYSTEM SMOOTH METAL WITH LEVER

G9B-514/45

Handtuchstange Länge 450 mm

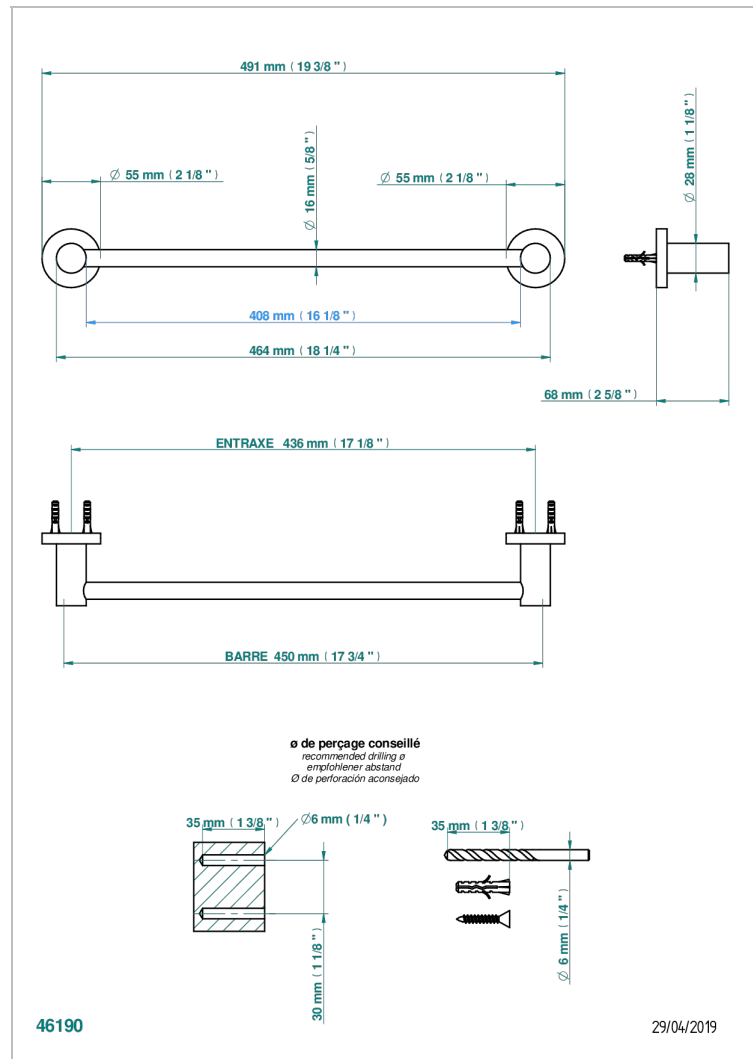

EIGENSCHAFTEN

- System Smooth Metal with lever
- Handtuchstange Länge 450 mm

VERFÜGBARE OBERFLÄCHEN

Altnickel - H28
Blassgold - F30
Blassgold matt unlackiert - F31
Bronze hell - D01
Chrom - A02
Chrom matt - C02

Gold - F01
Gold matt - F07
Kupfer altrot matt lackiert - H07
Mattschwarz keramik - D30
Nickel matt - C01
Polished chrome with gold inlay - GA1

Pvd blush - H62
Pvd blush matt - H60
Pvd bronze braun - F33
Pvd bronze braun matt - F34
Pvd gold - H52
Pvd gold matt - H53

Pvd graphite - H64
Pvd graphite matt - H65
Pvd messing - H49
Pvd messing matt - H50
Pvd nickel - H55
Pvd nickel matt - H56

Pvd umber - H66
Pvd umber matt - H67
Silbernickel - B01