

# AMBOISE RED JASPER

A1L-517

Single robe hook

THG<sup>®</sup>  
PARIS

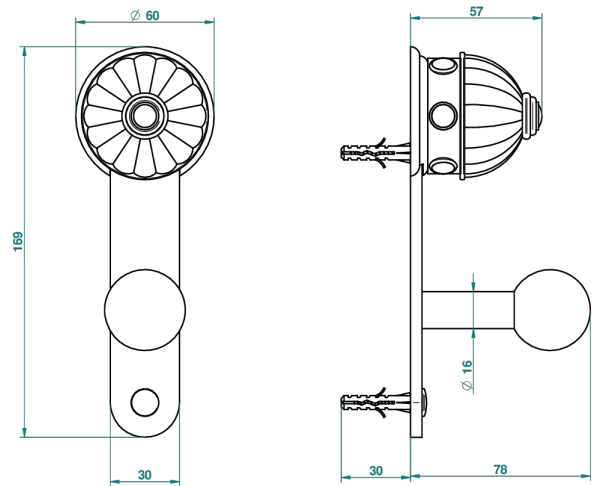

Ø de perçage conseillé  
recommended drilling Ø  
empfohlener Abstand  
Ø de perforación aconsejado



38263

28/05/2010

## CHARACTERISTIC

- Amboise Red Jasper
- Single robe hook

## AVAILABLE FINITIONS

Antique nickel - H28  
Black ceram - D30  
Blush PVD - H62  
Brass color PVD - H49  
Brown bronze color PVD - F33  
Gold color PVD - H52

Graphite PVD - H64  
Matt Umber PVD - H67  
Matt blush PVD - H60  
Matt brass color PVD - H50  
Matt brown bronze color PVD - F34  
Matt chrome - C02

Matt gold - F07  
Matt gold color PVD - H53  
Matt graphite PVD - H65  
Matt nickel (color finish) - C01  
Matt nickel color PVD - H56  
Nickel color PVD - H55

Polished chrome (color finish) - A02  
Polished chrome / Polished gold (color finish) - G02  
Polished gold (color finish) - F01  
Polished nickel - B01  
Soft gold - F30  
Soft matt gold - F31  
Umber PVD - H66