

MARQUISE, DEKOR GOLD

A7F-510

Bademantelhaken

THG[®]
PARIS

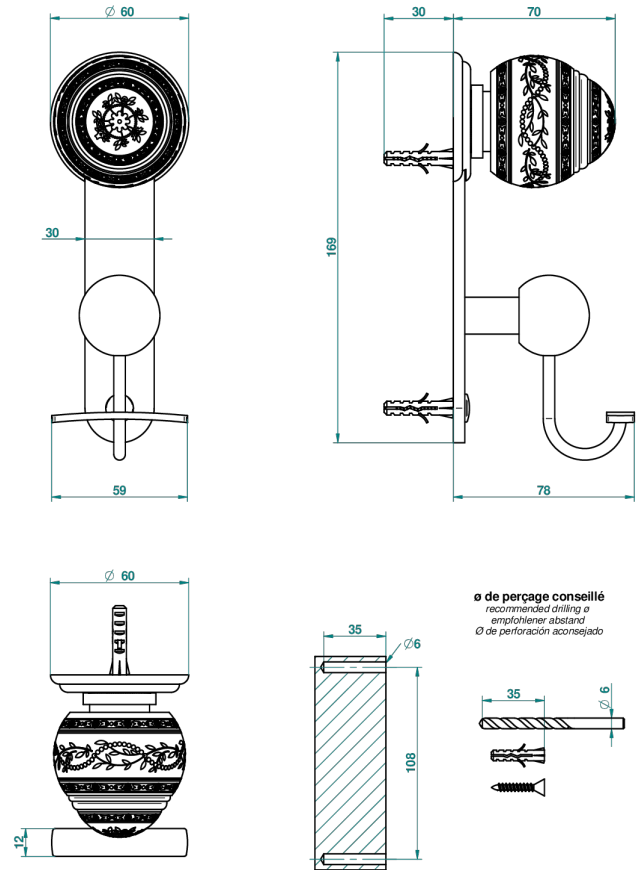

ø de perçage conseillé
recommended drilling ø
empfohlener Abstand
Ø de perforación aconsejado

35667

04/12/2012

EIGENSCHAFTEN

- Marquise, Dekor Gold
- Bademantelhaken

VERFÜGBARE OBERFLÄCHEN

Altnickel - H28
Blassgold - F30
Blassgold matt unlackiert - F31
Bronze hell - D01
Chrom - A02
Chrom / gold - G02

Chrom matt - C02
Gold - F01
Gold matt - F07
Kupfer altrot matt lackiert - H07
Mattschwarz keramik - D30
Nickel matt - C01

Pvd blush - H62
Pvd blush matt - H60
Pvd bronze braun - F33
Pvd bronze braun matt - F34
Pvd gold - H52
Pvd gold matt - H53

Pvd graphite - H64
Pvd graphite matt - H65
Pvd messing - H49
Pvd messing matt - H50
Pvd nickel - H55
Pvd nickel matt - H56

Pvd umber - H66
Pvd umber matt - H67
Silbernickel - B01