

1900, HEBEL

G28-508

Bademantelhaken

THG[®]
PARIS

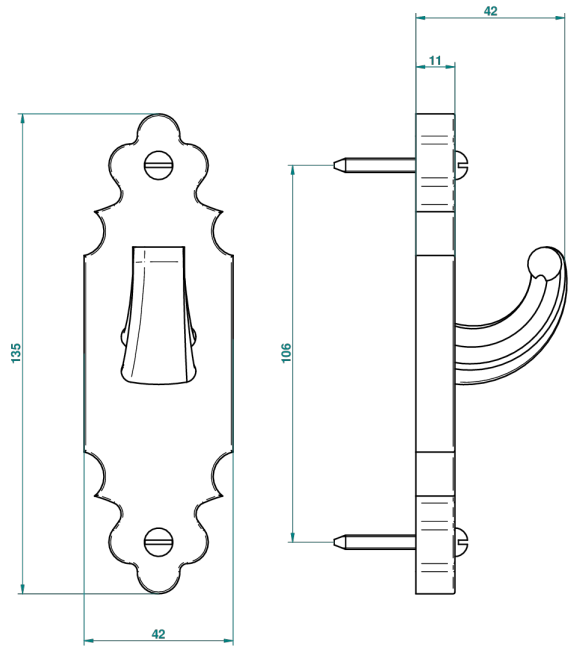

23765

29/09/2009

EIGENSCHAFTEN

- 1900, Hebel
- Bademantelhaken

VERFÜGBARE OBERFLÄCHEN

Altnickel - H28
Blassgold - F30
Blassgold matt unlackiert - F31
Bronze hell - D01
Chrom - A02
Chrom / gold - G02

Chrom matt - C02
Gold - F01
Gold matt - F07
Kupfer altrot matt lackiert - H07
Mattschwarz keramik - D30
Natural smoked Brass - A13

Nickel matt - C01
Pvd blush - H62
Pvd blush matt - H60
Pvd bronze braun - F33
Pvd bronze braun matt - F34
Pvd gold - H52

Pvd gold matt - H53
Pvd graphite - H64
Pvd graphite matt - H65
Pvd messing - H49
Pvd messing matt - H50
Pvd nickel - H55

Pvd nickel matt - H56
Pvd umber - H66
Pvd umber matt - H67
Silbernickel - B01