

# MANDARINE CRISTALLIA DIAMANT

U1K-508

Bademantelhaken

THG<sup>®</sup>  
PARIS

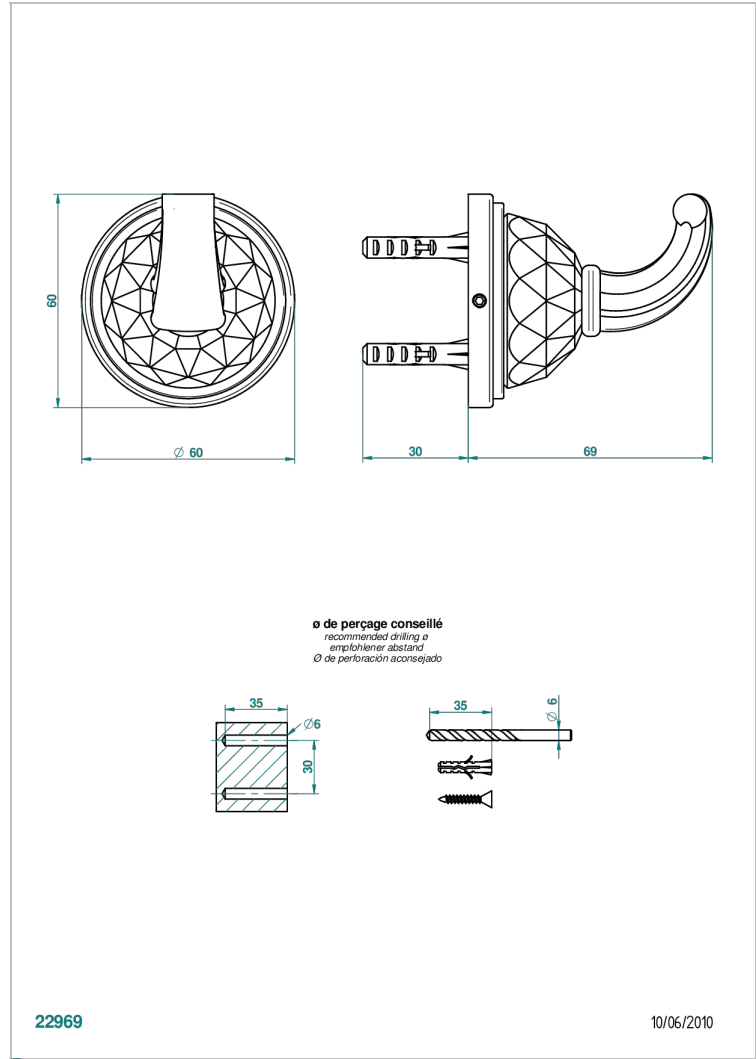

## EIGENSCHAFTEN

- Mandarin Crystallia Diamant
- Bademantelhaken

## VERFÜGBARE OBERFLÄCHEN

Altnickel - H28  
Blassgold - F30  
Blassgold matt unlackiert - F31  
Bronze hell - D01  
Chrom - A02  
Chrom / gold - G02

Chrom matt - C02  
Gold - F01  
Gold matt - F07  
Kupfer altrot matt lackiert - H07  
Mattschwarz keramik - D30  
Nickel matt - C01

Pvd blush - H62  
Pvd blush matt - H60  
Pvd bronze braun - F33  
Pvd bronze braun matt - F34  
Pvd gold - H52  
Pvd gold matt - H53

Pvd graphite - H64  
Pvd graphite matt - H65  
Pvd messing - H49  
Pvd messing matt - H50  
Pvd nickel - H55  
Pvd nickel matt - H56

Pvd umber - H66  
Pvd umber matt - H67  
Silbernickel - B01