

AMOUR DE TRIANON

G24-508

Bademantelhaken

THG[®]
PARIS

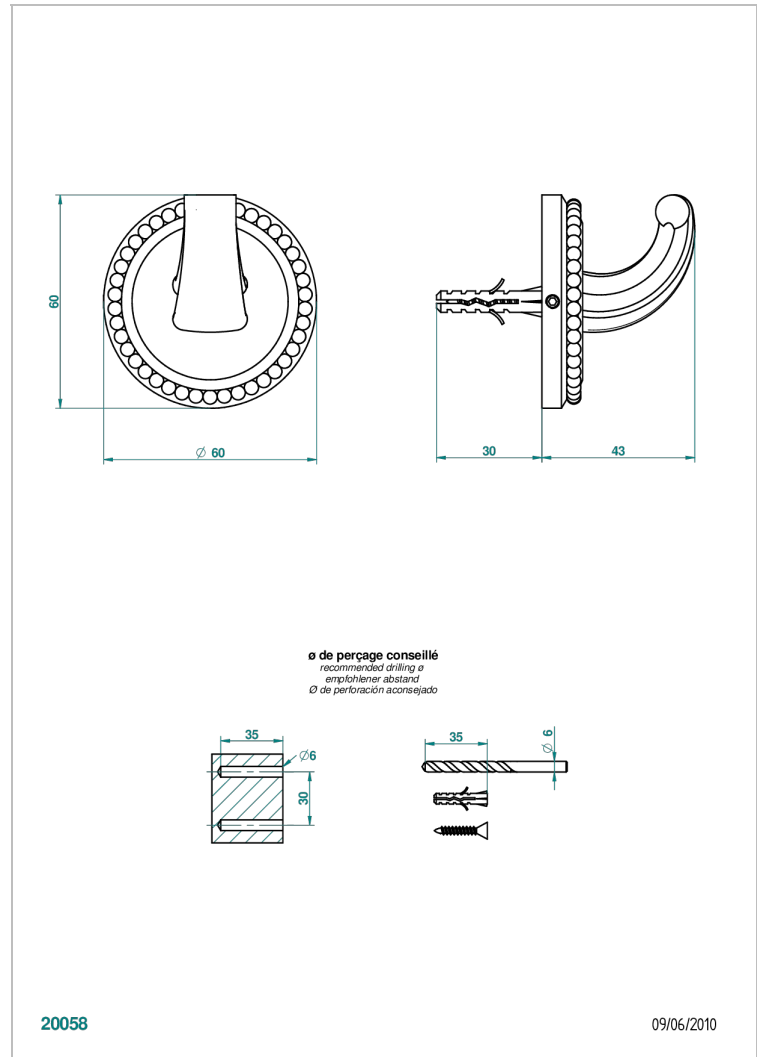

EIGENSCHAFTEN

- Amour de Trianon
- Bademantelhaken

VERFÜGBARE OBERFLÄCHEN

Altnickel - H28
Blassgold - F30
Blassgold matt unlackiert - F31
Bronze hell - D01
Chrom - A02
Chrom / gold - G02

Chrom matt - C02
Gold - F01
Gold matt - F07
Kupfer altrot matt lackiert - H07
Mattschwarz keramik - D30
Nickel matt - C01

Silbernickel - B01