

A59-151

3孔台盆龙头, 带下水器

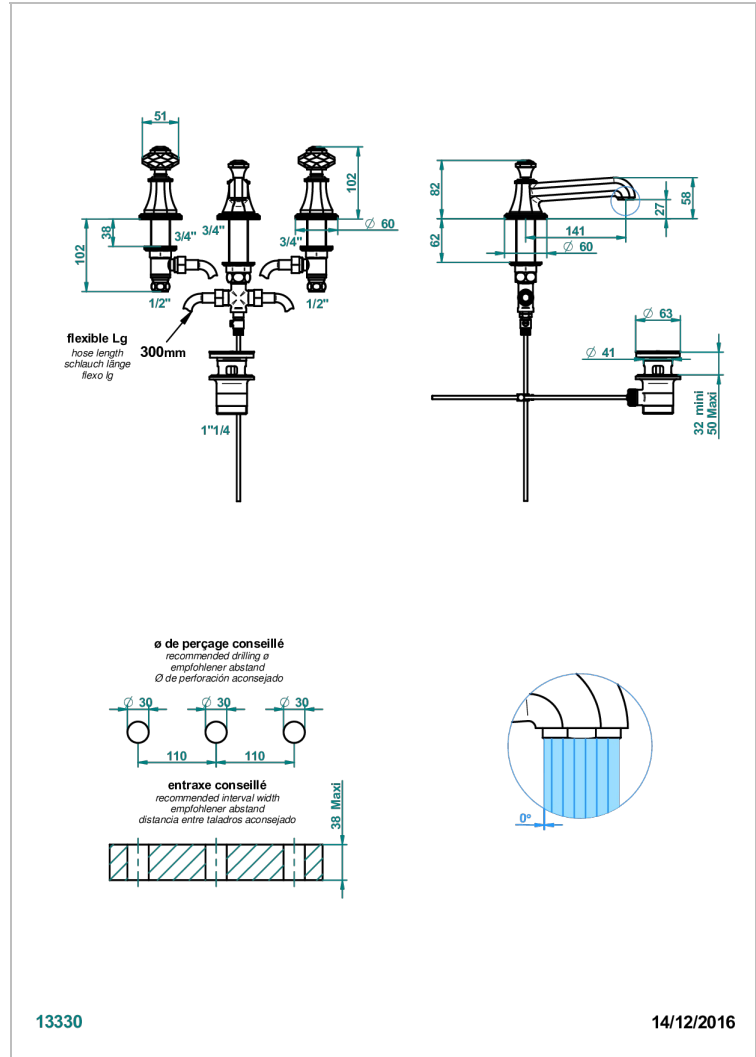

特色

- ACS : 18ACCLY393
- DVGW : DW-6051CN0450
- NF : NF EN 200 - IA - Chrome
- SVGW-SSIGE : 1901-6813

技术特征

- Recommandé : 3 bars (max. 5 bars) - Advised : 43,5 psi (max. 72 psi)
- 8,3 l/min à 3 bars (2.2 gpm at 43.5 psi)

标准



可选饰面

Black ceram - D30
Blush PVD - H62
Graphite PVD - H64
Matt Umber PVD - H67
Matt blush PVD - H60
Matt graphite PVD - H65

Natural smoked Brass - A13
PVD哑光棕铜 - F34
PVD哑光金 - H53
PVD哑光铜 - H50
PVD哑光镍 - H56
PVD抛光铜 - H49

PVD棕铜 - F33
PVD金色 - H52
PVD镍 - H55
Umber PVD - H66
哑光复古铜 - H07
哑光浅金 - F31

哑光金 - F07
哑光铬 - C02
哑光镍 - C01
复古镍 - H28
抛光金 (24K金) - F01
抛光铬 - A02

抛光铬/抛光金 - G02
抛光镍 - B01
浅金 - F30
漆面铜 - D01