

SOLUTIONS ÉLECTRONIQUES  
ELECTRONIC SOLUTIONS  
2022



THG<sup>®</sup>  
P A R I S



# SOMMAIRE | SUMMARY



## DÉTECTION DE PROXIMITÉ PROXIMITY SENSOR

PRÉSENTATION   PRESENTATION.....	4
INFORMATIONS TECHNIQUES   TECHNICAL INFORMATION.....	20



## DÉTECTION INFRAROUGE INFRARED SENSOR

PRÉSENTATION   PRESENTATION.....	8
INFORMATIONS TECHNIQUES   TECHNICAL INFORMATION.....	22



## COMMANDE ÉLECTRONIQUE TACTILE ELECTRONIC TOUCH CONTROL

PRÉSENTATION   PRESENTATION.....	12
INFORMATIONS TECHNIQUES   TECHNICAL INFORMATION.....	26



ACCESSOIRES   ACCESSORIES.....	36
--------------------------------	----



COLLECTIONS   COLLECTIONS.....	38
FINITIONS   FINISHES.....	48

ATTACH  
TOP  
W/  
72



2x6  
TRUS

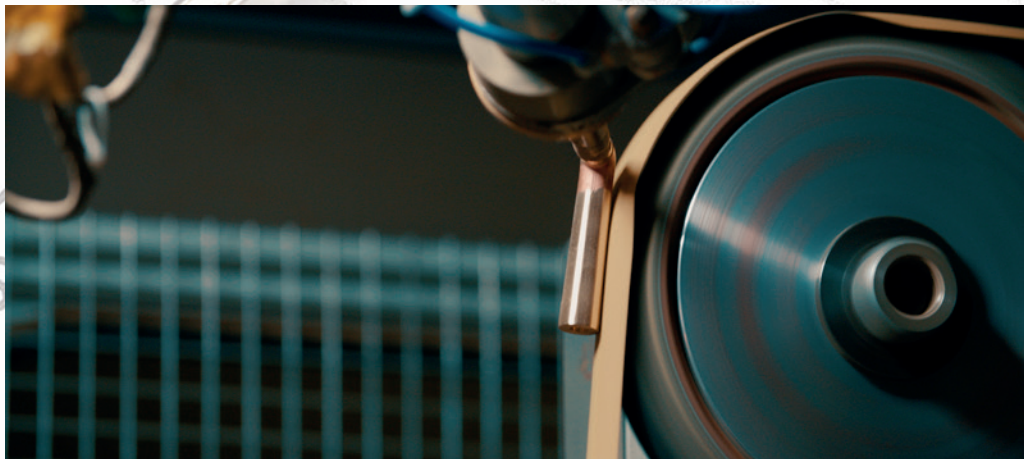

WOOD BEAM, SEE

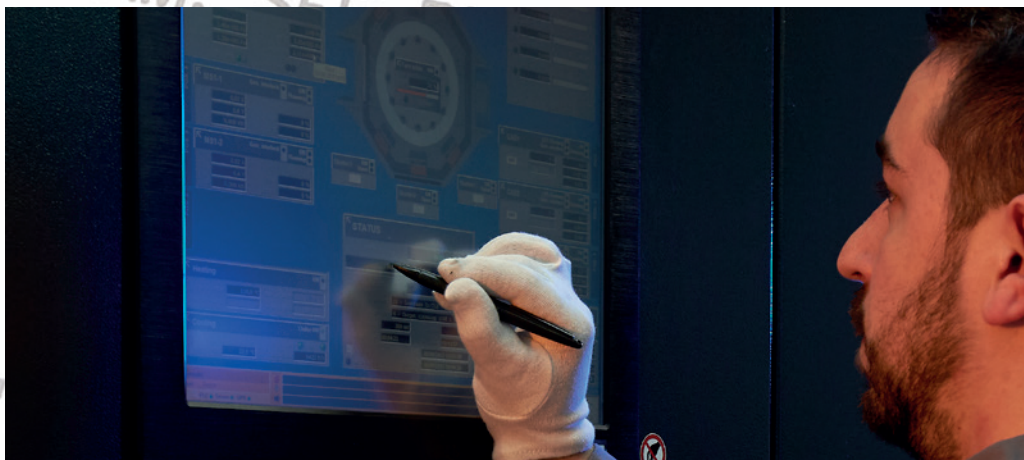

X-

SCALE: 3/4" = 1'-0"



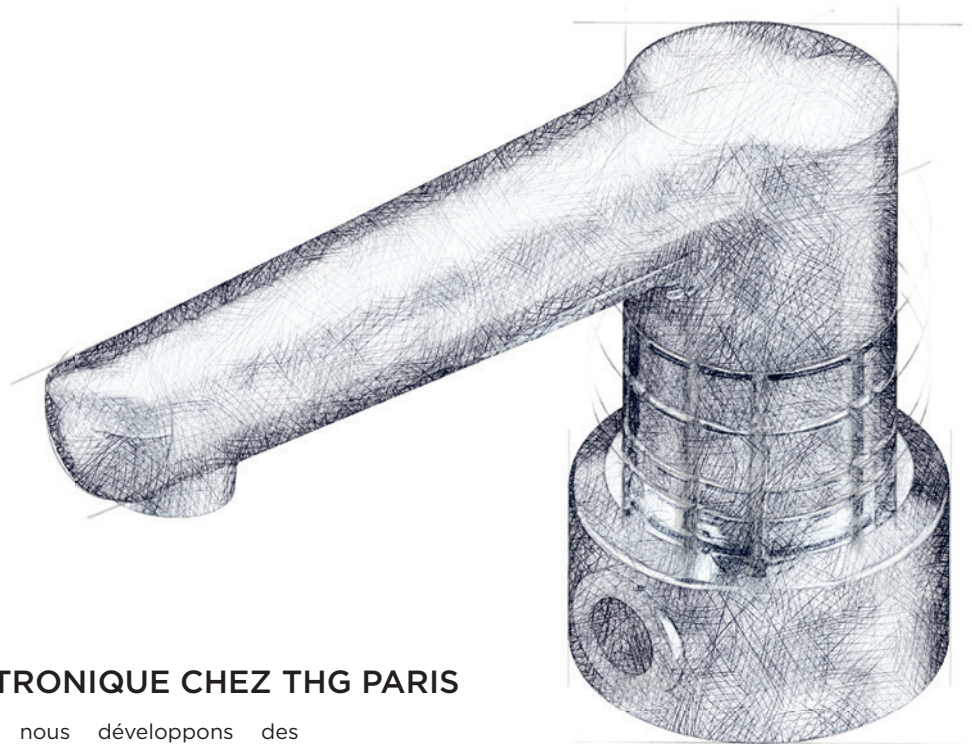

## LA TECHNOLOGIE ÉLECTRONIQUE CHEZ THG PARIS

Depuis plus de 10 ans, nous développons des produits électroniques pour répondre à vos besoins. Notre bureau d'étude travaille sur différentes technologies intuitives :



DÉTECTION DE PROXIMITÉ



DÉTECTION INFRAROUGE



COMMANDE ÉLECTRONIQUE TACTILE

Grâce à notre savoir-faire, nous adaptons la technologie sans sacrifier le design pour vous proposer des collections esthétiques, fonctionnelles et simples à installer.

## ELECTRONIC TECHNOLOGY AT THG PARIS

For over 10 years, we have been developing electronic products to meet your needs.

Our design office works on different intuitive technologies:



PROXIMITY SENSOR



INFRARED SENSOR



ELECTRONIC TOUCH CONTROL

Thanks to our know-how, we adapt the technology without sacrificing the design to offer you aesthetic, functional and easy to install collections.



## DÉTECTION DE PROXIMITÉ

L'eau coule grâce à un simple mouvement à proximité du robinet.

- Pas de capteur visible
- Hygiénique
- Économies d'eau et d'énergie
- Disponible dans toutes les collections

Retrouvez les informations techniques page 20.

## PROXIMITY SENSOR

The water flows with a simple movement near the tap.

- No visible sensor
- Hygienic
- Water and energy saving
- Available in all collections

See technical information on page 20.

4



**Cygne G31.F01**

Doré | Polished gold

**MEN**

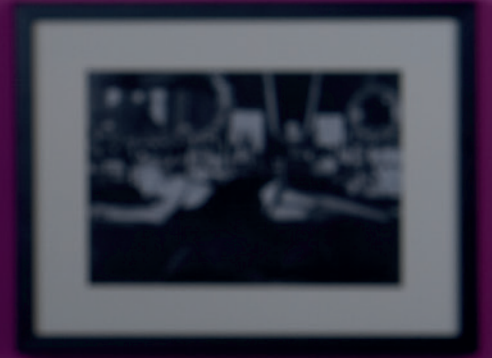





**Icon-X U7G.A02**

Chrome | Polished chrome



**Pure G04.F30**  
Or pâle | Soft gold



**Grand Central U9K.F33**  
PVD couleur bronze brown |  
Brown bronze color PVD





## DÉTECTION INFRAROUGE

Technologie par détection infrarouge : la cellule détecte la présence de l'utilisateur et déclenche l'ouverture automatique de l'eau.

- Hygiénique
- Économies d'eau et d'énergie
- Préconisée en hôtellerie

Retrouvez les informations techniques page 22.

## INFRARED SENSOR

Infrared detection technology: the sensor detects the presence of the user and triggers an automatic flow of water.

- Hygienic
- Water and energy saving
- Recommended for hotels

See technical information on page 22.



**Art Déco A54.B01**

Nickel | Polished nickel



Avec mitigeur pour régler manuellement la température  
With deck mounted mixing valve for manual temperature control

**Les Ondes G8A.F30**

Or pâle | Soft gold



**1900 G25.F30**

Or pâle | Soft gold

**Charleston G29.C01**

Nickel mat | Matt nickel







**Soho G5E.A02**  
Chrome | Polished chrome



**Icon-X U7G.A02**

Chrome | Polished chrome

Disponible en version murale  
ou sur gorge.

Available as wall mounted  
or integrated deck mount  
versions.

**System Métal quadrillé |  
Squared Metal G9E.D05**

Bronze clair vernis mat |  
Lacquered matt bronze





# E

## COMMANDE ÉLECTRONIQUE TACTILE

Une simple pression sur le bouton ouvre et ferme l'eau et la température se règle en le tournant.

- Grande souplesse de commande
- Confort et sécurité : régulation électronique de la température et du débit
- Visualisation de la montée en température par technologie LED
- Économies d'eau et d'énergie
- Préconisée en hôtellerie et en résidentiel privé

Retrouvez les informations techniques page 26.

## ELECTRONIC TOUCH CONTROL

A simple press on the button opens and closes the water flow and the temperature is adjusted by turning it.

- High control flexibility
- Comfort and safety: electronic temperature and flow control
- Visualisation of the temperature rise by LED technology
- Saving water and energy
- Recommended for hotels and private homes

See technical information on page 26.







**1900 G25.F30**  
Or pâle | Soft gold



**Dean G7E.A02**

Chrome | Polished chrome

14

Bouton utilisable avec des becs  
muraux ou sur gorge  
Control can be used with wall or deck  
spouts



**Icon-X U7G.A02**

Chrome | Polished chrome





**Masque de Femme A2U.A02**  
Chrome | Polished chrome

15



**Pure G04.F30**  
Or pâle | Soft gold

Fonction double : bain et douche  
Dual function: bath and handshower



**Icon-X U7G.A02**  
Chrome | Polished chrome

16



**Icon-X à manettes |  
with lever handles U7H.A02**  
Chrome | Polished chrome

Fonction simple : bouton pour douche  
Simple function: button for handshower





Hirondelles tamponnées or |  
Gold stamped A4L.F30  
Or pâle | Soft gold





**Icon-X U7G.H65**

PVD couleur graphite mat |

Matt graphite color PVD



**INFORMATIONS TECHNIQUES**  
**TECHNICAL INFORMATION**





# DÉTECTION DE PROXIMITÉ : ÉLÉMENTS TECHNIQUES

## PROXIMITY SENSOR: TECHNICAL ELEMENTS

### PRINCIPE | PRINCIPLE

Déclenchement sans contact. Quand la main approche à moins de 5 cm du bec, l'eau s'écoule et stoppe 2 secondes après le retrait des mains.  
 Touchless triggering. At a distance less than 2" from the spout, water flows and stops 2 seconds after hands are removed.

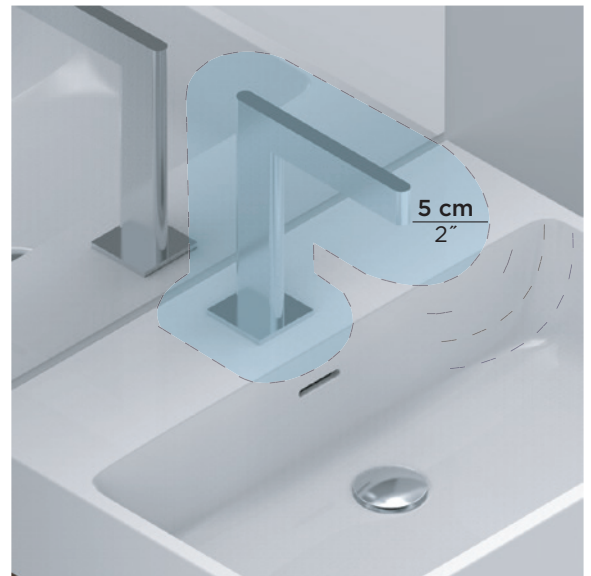

### ALIMENTATION | POWER SUPPLY



6 x LR6

### COMPOSITION TECHNIQUE | TECHNICAL COMPOSITION

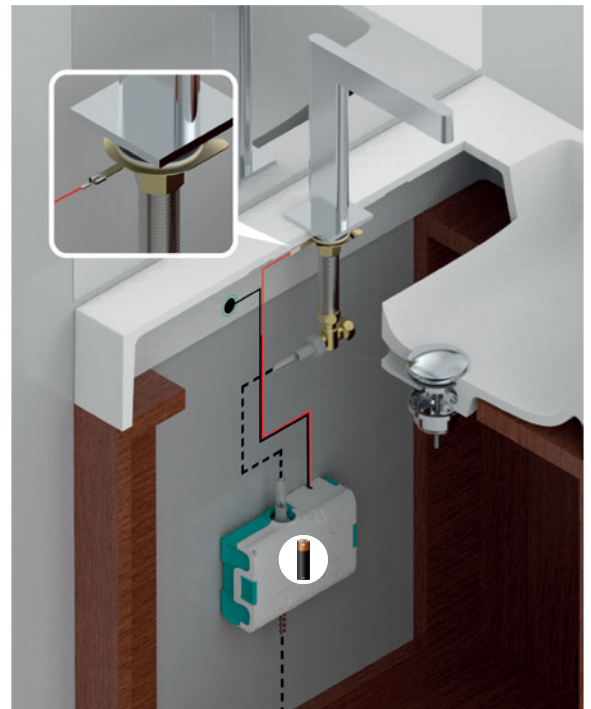

20

### MODE NETTOYAGE | CLEANING MODE

La fonction nettoyage permet de bloquer la détection et donc d'éviter que l'eau ne coule quand on approche ses mains. Pour activer la fonction nettoyage, appuyer 60 secondes sur le bouton de contrôle du boîtier.  
 The cleaning function allows you to block the detection and therefore prevent water from flowing when you approach your hands. To activate the cleaning function, press the control button on the casing for 60 seconds.

### NORMES | CERTIFICATIONS



IP55

NOTICE D'INSTALLATION  
 INSTALLATION INSTRUCTIONS





# COMMENT COMMANDER DES BECS À DÉTECTION DE PROXIMITÉ ? HOW TO SPECIFY A PROXIMITY SENSOR BASIN SET?

## 1 CHOISIR UNE COLLECTION | CHOOSE A COLLECTION

Exemple de référence à indiquer | Example of part number to use: **G1T - 170E**

Bec | Standard spout: 170E



Bec haut | High spout: 172E



Retrouvez toutes nos collections | Find all our collections  
Page 36

21

## 2 RÉGLAGE DE LA TEMPÉRATURE\* | INDICATE METHOD OF SETTING THE TEMPERATURE\*



**5999**

Mitigeur thermostatique ½", à dissimuler  
½" Concealed wall mounted thermostat



**6532**

Mitigeur progressif sur gorge  
Rim mounted progressive mixer

## 3 CHOISIR UN SIPHON\* | CHOOSE A TRAP\*



**308T**

Siphon culot réglable  
Adjustable bottle trap



**309/S**

Siphon design apparent  
Bottle trap only for waste



**315L**

Siphon tube  
Adjustable «P» trap

\* Optionnel | Optional



# DÉTECTION INFRAROUGE SUR GORGE : ÉLÉMENTS TECHNIQUES

## RIM MOUNTED INFRARED SENSOR: TECHNICAL ELEMENTS

### PRINCIPE | PRINCIPLE

Déclenchement sans contact. Quand la main approche à une distance comprise entre 5 et 25 cm, l'eau s'écoule et stoppe 2 secondes après le retrait des mains.

Touchless triggering. At a distance of 2" to 10", water flows out and stops 2 seconds after hands are removed.

### ALIMENTATION | POWER SUPPLY



110 - 220 V  
Secteur | Electrical outlet

Ou | Or



Pile 6V | Battery



### COMPOSITION TECHNIQUE | TECHNICAL COMPOSITION

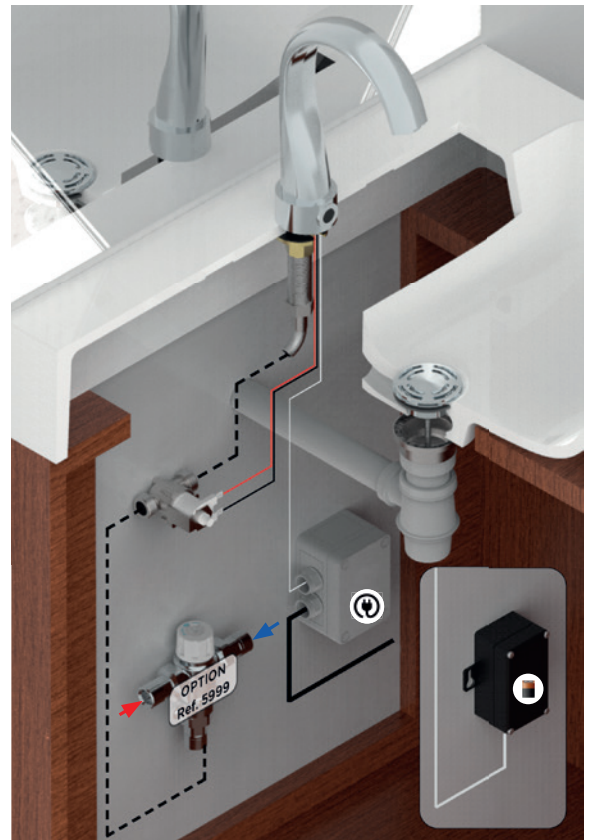

### NORMES | CERTIFICATIONS



IP65

NOTICE D'INSTALLATION  
INSTALLATION INSTRUCTIONS







# COMMENT COMMANDER DES BECS INFRAROUGE SUR GORGE ? HOW TO SPECIFY A RIM MOUNTED INFRARED SPOUT?

## 1 CHOISIR UNE COLLECTION | CHOOSE A COLLECTION

Exemple de référence à indiquer | Example of part number to use: **G1T**

Bec | Standard spout: 170IRS / 170IRB



Retrouvez toutes nos collections | Find all our collections  
Page 38

## 2 INDiquer LA RÉFÉRENCE DE L'ARTICLE SELON LE TYPE D'ALIMENTATION INDICATE THE SPOUT PART NUMBER ACCORDING TO THE TYPE OF SUPPLY



**170IRS**

Bec infrarouge sur gorge, sur secteur  
Rim mounted infrared spout, on mains



**170IRB**

Bec infrarouge sur gorge, à piles  
Rim mounted infrared spout, battery operated

23

## 3 RÉGLAGE DE LA TEMPÉRATURE\* | INDICATE METHOD OF SETTING THE TEMPERATURE\*

**5999**

Mitigeur thermostatique ½",  
à dissimuler  
½" Concealed wall mounted  
thermostat



**6532**

Mitigeur progressif sur gorge  
Rim mounted progressive mixer



Collectif | Collective



**5200AE**

Mitigeur thermostatique à encastrer  
Concealed thermostatic mixing valve

+



**5100BR**

## 4 CHOISIR UNE BONDE\* | CHOOSE A WASTE\*

**316**

Vidage clic clac  
Click waste



**309/B**

Bonde à écoulement libre  
Free-flow basin waste  
with grid



## 5 CHOISIR UN SIPHON\* | CHOOSE A TRAP\*

**308T**

Siphon culot  
réglable  
Adjustable bottle  
trap



**309/S**

Siphon design  
apparent  
Bottle trap only  
for waste



**315L**

Siphon tube  
Adjustable «P» trap



\* Optionnel | Optional



# DÉTECTION INFRAROUGE MURALE : ÉLÉMENTS TECHNIQUES

## WALL MOUNTED INFRARED SENSOR: TECHNICAL ELEMENTS

### PRINCIPE | PRINCIPLE

Déclenchement sans contact. Quand la main approche à une distance comprise entre 5 et 25 cm, l'eau s'écoule et stoppe 2 secondes après le retrait des mains.

Touchless triggering. At a distance of 2" to 10", water flows out and stops 2 seconds after hands are removed.

### ALIMENTATION | POWER SUPPLY



Secteur | Electrical outlet

Ou | Or



Pile 6V | Battery

### NORMES | CERTIFICATIONS



IP65

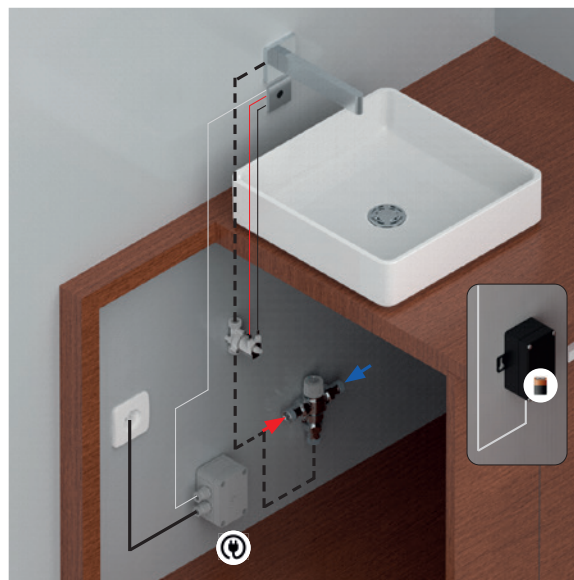
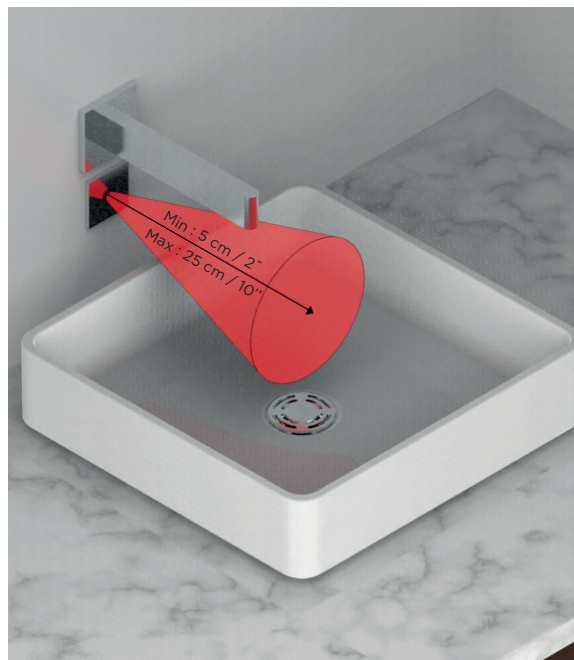

**NOTICE D'INSTALLATION**  
**INSTALLATION INSTRUCTIONS**







# COMMENT COMMANDER DES BECS INFRAROUGE MURAUX ? HOW TO SPECIFY A WALL MOUNTED INFRARED SPOUT?

## 1 CHOISIR UNE COLLECTION | CHOOSE A COLLECTION

Exemple de référence à indiquer | Example of part number to use: **G1T - 22GAB**



Retrouvez toutes nos collections | Find all our collections  
Page 40

## 2 INDIQUER LA RÉFÉRENCE DE L'ARTICLE ET CHOISIR LA CELLULE INDICATE THE SPOUT PART NUMBER ALONG WITH POWER SOURCE AND TRIM SHAPE



**22GAB**  
Bec mural  
Wall mounted spout

+



Ou | Or



Carré | Square



**6702C**

Ou | Or

Rond | Round



**6702R**



Carré | Square



**6702CB**

Ou | Or

Rond | Round



**6702RB**

25

## 3 RÉGLAGE DE LA TEMPÉRATURE\* | INDICATE METHOD OF SETTING THE TEMPERATURE\*



**5999**  
Mitigeur thermostatique ½",  
à dissimuler  
½" Concealed wall mounted  
thermostat



**6532**  
Mitigeur progressif sur gorge  
Rim mounted progressive mixer

Collectif | Collective



**5200AE**

+



**5100BR**

Mitigeur thermostatique à encastrer  
Concealed thermostatic mixing valve

## 4 CHOISIR UNE BONDE\* | CHOOSE A WASTE\*



**316**  
Vidage clic clac  
Click waste



**309/B**  
Bonde à écoulement libre  
Free-flow basin waste  
with grid

## 5 CHOISIR UN SIPHON\* | CHOOSE A TRAP\*



**308T**  
Siphon culot  
réglable  
Adjustable bottle  
trap



**309/S**  
Siphon design  
apparent  
Bottle trap only  
for waste



**315L**  
Siphon tube  
Adjustable «P» trap

\* Optionnel | Optional

# E COMMANDE ÉLECTRONIQUE TACTILE : ÉLÉMENTS TECHNIQUES

## ELECTRONIC TOUCH CONTROL: TECHNICAL ELEMENTS

### PRINCIPE | PRINCIPLE

Déclenchement de l'eau et réglage de la température par bouton. La couleur de la lumière indique la température.

Water triggering and temperature setting by control. The colour of the light indicates the temperature.

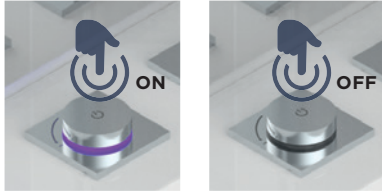

### ALIMENTATION | POWER SUPPLY



110 - 220 V  
Secteur | Electrical outlet

### SÉCURITÉ TEMPÉRATURE | TEMPERATURE SAFETY

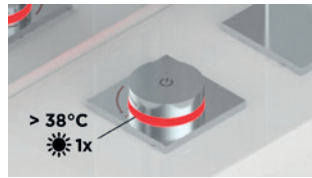
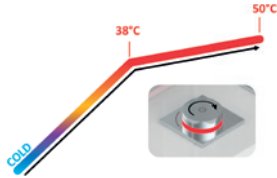

Eau à 38°C |  
100°F water

26

### PRÉRÉGLAGES | PRESETTINGS



Eau froide |  
Cold water



Eau à 30°C |  
86°F water



Eau à 38°C |  
100°F water

### MODE NETTOYAGE | CLEANING MODE

Pour éviter que le robinet ne s'ouvre pendant le nettoyage, la fonction aquastop désactive temporairement le capteur. Pour activer cette fonction, restez appuyé sur le bouton de commande jusqu'à ce qu'il soit vert. Le capteur reste inactif pendant 60 secondes.

To ensure that the faucet doesn't open during cleaning, the aquastop function temporarily deactivates the sensor. To activate this function, press and hold the control button until it is green. The sensor remains inactive for 60 seconds.



### DONNÉES TECHNIQUES | TECHNICAL DATA

- Débit lavabo selon norme en vigueur | Washbasin flow rate according to standard
- Pression recommandée | Recommended pressure: 0,5 > 5 bars

### NORMES | CERTIFICATIONS



**IPX4**



# **E** COMMANDE ÉLECTRONIQUE TACTILE : MITIGEUR DE LAVABO ELECTRONIC TOUCH CONTROL: RIM MOUNTED BASIN SPOUT

## ALIMENTATION | POWER SUPPLY



110 - 220 V  
Secteur | Electrical outlet  
2 mètres de câble | 6,5 ft of cable

## COMPOSITION TECHNIQUE | TECHNICAL COMPOSITION



**NOTICE D'INSTALLATION**  
INSTALLATION INSTRUCTIONS

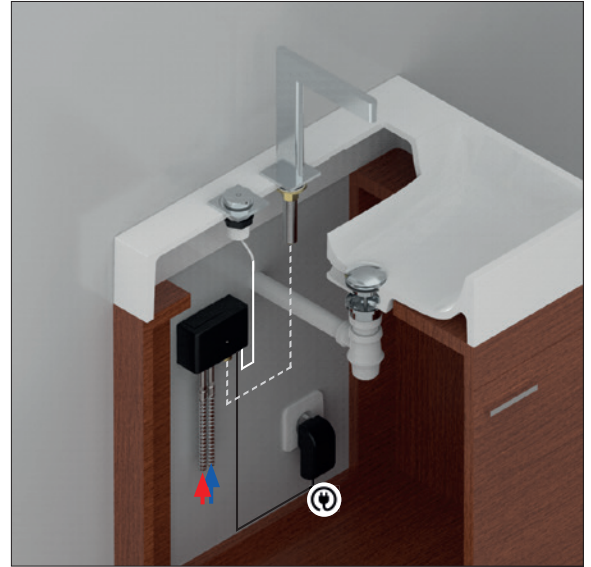

# **E** COMMENT COMMANDER DES MITIGEURS DE LAVABO TACTILES ? HOW TO SPECIFY TOUCH CONTROL RIM MOUNTED SPOUT?

## 1 CHOISIR UNE COLLECTION | CHOOSE A COLLECTION

Exemple de référence à indiquer | Example of part number to use: **G9A - 170V**

Bec | Standard spout: 170V



Bec haut | High spout: 172V



Retrouvez toutes nos collections | Find all our collections  
Page 36

## 2 CHOISIR UN SIPHON\* | CHOOSE A TRAP\*



**308T**  
Siphon culot réglable  
Adjustable bottle trap



**309/S**  
Siphon design apparent  
Bottle trap only for waste



**315L**  
Siphon tube  
Adjustable «P» trap

\* Optionnel | Optional

# **E** COMMANDE ÉLECTRONIQUE TACTILE : MITIGEUR DE LAVABO MURAL ELECTRONIC TOUCH CONTROL: WALL MOUNTED BASIN SPOUT

## ALIMENTATION | POWER SUPPLY



110 - 220 V  
Secteur | Electrical outlet  
2 m de câble | 6,5 ft of cable

NOTICE D'INSTALLATION  
INSTALLATION INSTRUCTIONS



# **E** COMMENT COMMANDER DES MITIGEURS DE LAVABO TACTILES MURAUX ? HOW TO ORDER TOUCH CONTROL WALL MOUNTED SPOUT?

## 1 CHOISIR UNE COLLECTION | CHOOSE A COLLECTION

Exemple de référence à indiquer | Example of part number to use: **G9A - 22GAB**



Retrouvez toutes nos collections | Find all our collections  
Page 40

## 2 INDIQUER LA RÉFÉRENCE DE L'ARTICLE ET CHOISIR LE BOUTON INDICATE THE SPOUT PART NUMBER AND CHOOSE THE BUTTON SHAPE; ADD SYSTEM



**22GAB**  
Bec mural  
Wall mounted spout

Carré | Square



**6770B**

Ou | Or

Rond | Round



**6770RB**

+



**6770A**



**3** CHOISIR UNE BONDE\* | CHOOSE A WASTE\*



**316**  
Vidage clic clac  
Click waste



**309/B**  
Bonde à écoulement libre  
Free-flow basin waste with grid

**4** CHOISIR UN SIPHON\* | CHOOSE A TRAP\*



**308T**  
Siphon culot réglable  
Adjustable bottle trap



**309/S**  
Siphon design apparent  
Bottle trap only for waste



**315L**  
Siphon tube  
Adjustable «P» trap



\* Optionnel | Optional





# **E** COMMANDE ÉLECTRONIQUE TACTILE : BAIN DOUCHE ELECTRONIC TOUCH CONTROL: BATHTUB

## ALIMENTATION | POWER SUPPLY

 110 - 220 V  
 Secteur | Electrical outlet  
 6 m | 19 ¾ ft of cable

ON/OFF   
 Réglage de la température | Temperature setting   
 Eau à 38°C | 100°F water  X3

Inverseur bain/douchette | Bath/shower diverter   
 Réglage du débit | Flow rate adjustment 

**NOTICE D'INSTALLATION**  
**INSTALLATION INSTRUCTIONS**

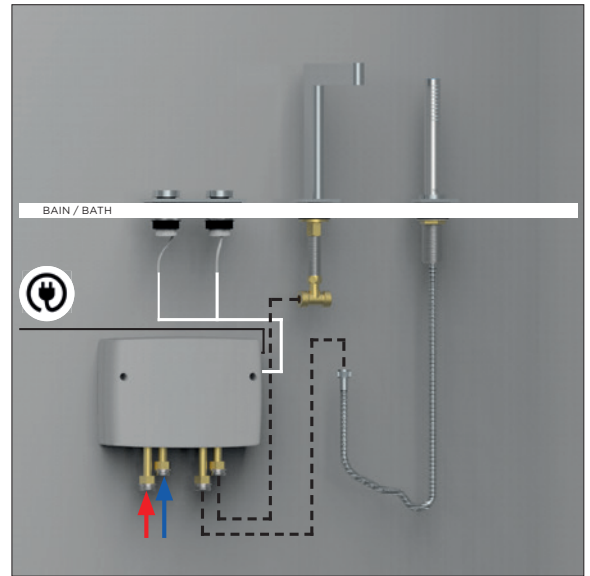

# **E** COMMENT COMMANDER DU TACTILE POUR BAIN DOUCHE ? HOW TO SPECIFY TOUCH CONTROL FOR BATHTUB?

## 1 CHOISIR UNE SOLUTION | CHOOSE A SOLUTION

30

Sur gorge | Rim mounted

Mural | Wall mounted

### 2 CHOISIR UN BEC DE BAIN CHOOSE A BATH SPOUT



### 2 CHOISIR UN BEC DE BAIN CHOOSE A BATH SPOUT



### 3 CHOISIR LES BOUTONS | CHOOSE THE BUTTONS

Carré | Square

Rond | Round



Ou | Or



+



6760D

6760DR

Inclus | Included

### 3 CHOISIR LES BOUTONS | CHOOSE THE BUTTONS

Carré | Square

Rond | Round

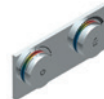

Ou | Or



+



6770DB

6770DRB

6770DA

### 4 CHOISIR UNE DOUCHETTE CHOOSE A HANDSHOWER



### 4 CHOISIR UNE DOUCHETTE CHOOSE A HANDSHOWER



**EXEMPLE DE COMPOSITION | EXAMPLE OF COMPOSITION**

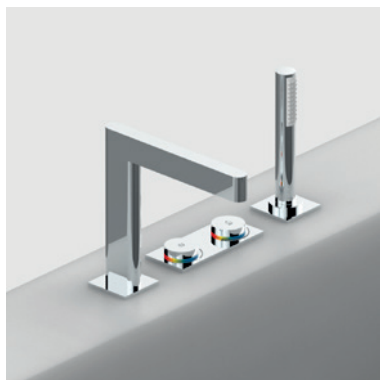

**29SG - 6760D - 60A**

Ensemble mitigeur de bain à commande électronique avec vidage  
Rim mounted bath mixer with electronic control and pop-up waste



U9A - 29SGB + G00 - 6760DR + U9A - 60A



G04 - 29SG + G00 - 6760D + G04 - 58



**42SGB - 6770DB - 6770DA - 54**

Ensemble mitigeur de bain mural, à commande électronique avec vidage  
Wall mounted bath mixer with electronic control and pop-up waste



U9A - 42GB + G00 - 6770DRB + G00 - 6770DA + U9A - 54

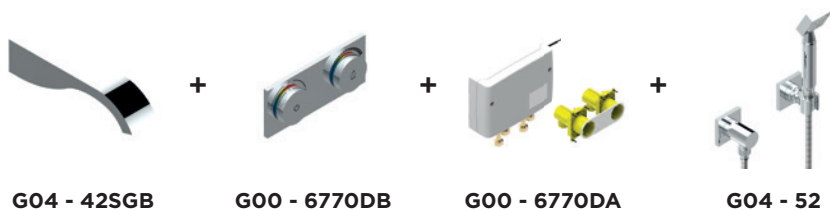

G04 - 42SGB + G00 - 6770DB + G00 - 6770DA + G04 - 52



**Baubourg G7A.F30**

Or pâle | Soft gold



# **E** COMMANDE ÉLECTRONIQUE TACTILE : BAIN AVEC DOUCHETTE SEULE ELECTRONIC TOUCH CONTROL: BATHTUB WITH HANDSHOWER CONTROL ONLY

## ALIMENTATION | POWER SUPPLY



110 - 220 V  
Secteur | Electrical outlet  
2 m de câble | 6,5 ft of cable

### NOTICE D'INSTALLATION INSTALLATION INSTRUCTIONS

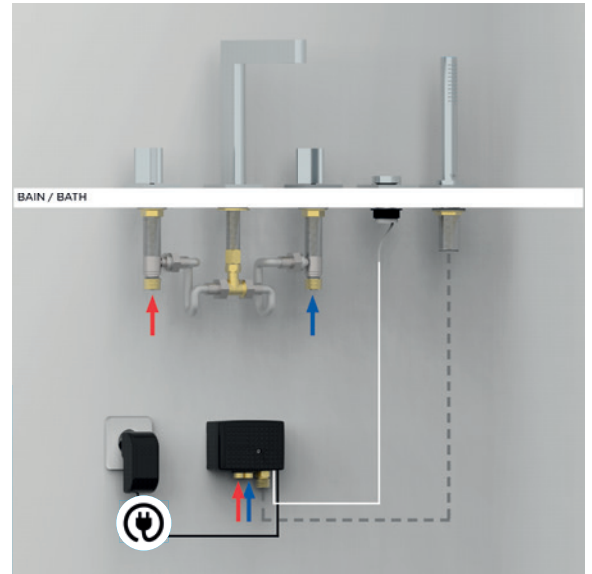

## **E** COMMENT COMMANDER DU TACTILE POUR BAIN AVEC DOUCHETTE SEULE ? HOW TO ORDER TOUCH CONTROL FOR BATHTUB WITH HANDSHOWER ONLY?

### 1 CHOISIR UN MÉLANGEUR | CHOOSE A MIXER

Sur gorge | Rim mounted      Mural | Wall mounted



Ou | Or



32

### 2 CHOISIR L'EMPLACEMENT DE LA DOUCHETTE | CHOOSE THE LOCATION OF THE HANDSHOWER

Sur gorge | Rim mounted

Mural | Wall mounted

### 3 CHOISIR LE BOUTON | CHOOSE THE BUTTON

Carré | Square      Rond | Round



Ou | Or



+



6760

6760R

Inclus | Included

### 4 CHOISIR UNE DOUCHETTE CHOOSE A HANDSHOWER



### 3 CHOISIR LE BOUTON | CHOOSE THE BUTTON

Carré | Square      Rond | Round



Ou | Or



+



6770B

6770RB

6770A

### 4 CHOISIR UNE DOUCHETTE CHOOSE A HANDSHOWER



**EXEMPLE DE COMPOSITION | EXAMPLE OF COMPOSITION**



**25SG - 6760 - 60A**

Ensemble mélangeur de bain avec douchette eau mitigée électronique

Bath mixer set with electronic water mixer and handshower



**G29 - 25SGH**

**G00 - 6760R**

**U9A - 60A**

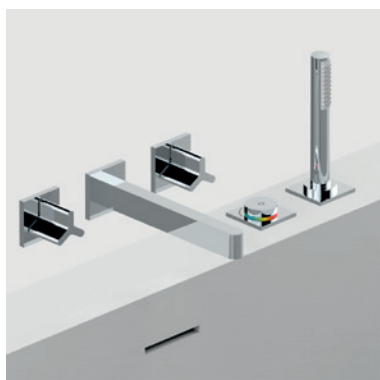

**41SGB - 40AC - 6760 - 60A**

Ensemble mélangeur de bain mural avec douchette eau mitigée électronique sur gorge

Wall mounted bath mixer and deck mounted handshower

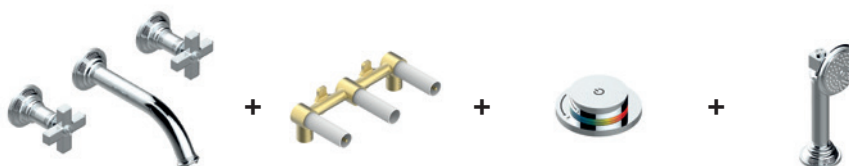

**U9A - 41GB**

**G00 - 40AC**

**G00 - 6760R**

**U9A - 60A**



**Icon-X U7G.A02**

Chrome | Polished chrome

# **E** COMMANDE ÉLECTRONIQUE TACTILE : DOUCHE DEUX FONCTIONS ELECTRONIC TOUCH CONTROL: DUAL FUNCTION SHOWER

## ALIMENTATION | POWER SUPPLY



110 - 220 V  
Secteur | Electrical outlet  
6 m de câble | 19 ¾ ft of cable

ON/OFF

Réglage de la température | Temperature setting

Eau à 38°C | 100°F water X3

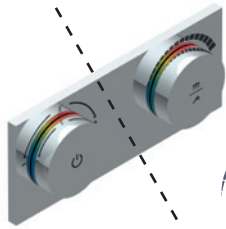

Inverseur bain/douchette | Bath/shower diverter

Réglage du débit | Flow rate adjustment

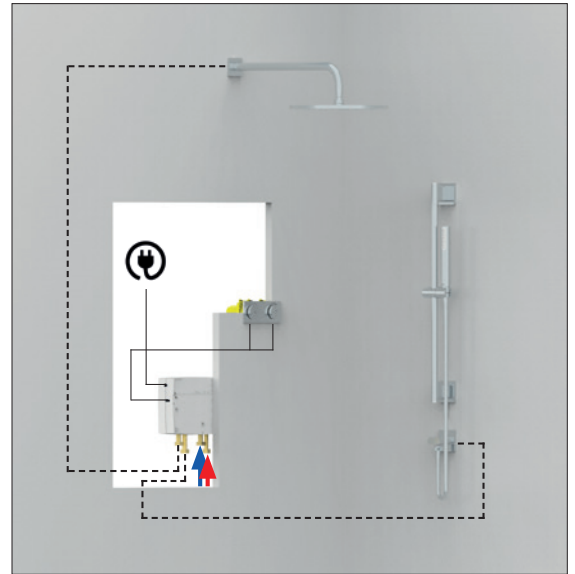

**NOTICE D'INSTALLATION**  
INSTALLATION INSTRUCTIONS



# **E** COMMENT COMMANDER DU TACTILE POUR UNE DOUCHE DEUX FONCTIONS ? HOW TO SPECIFY TOUCH CONTROL FOR A DUAL FUNCTION SHOWER?

34

## **1** CHOISIR UNE COLLECTION ET UN MODÈLE DE DOUCHETTE CHOOSING A COLLECTION AND MODEL OF HANDSHOWER

Exemple de référence à indiquer | Example of part numbers to indicate: **U4A - 52**



**U4A - 52**



**U4A - 54**



**U4A - 58**



**G5E - 52**



**G5E - 54**



**G5E - 58**

Retrouvez toutes nos collections sur | Find all our collections on  
[WWW.THG-PARIS.COM](http://WWW.THG-PARIS.COM)

## **2** CHOISIR LES BOUTONS | CHOOSE THE BUTTONS

Carré | Square

Rond | Round



**6772DB**

Ou | Or



**6772DRB**

+



**6770DA**



**3**

**CHOISIR UNE POMME DE DOUCHE | CHOOSING A SHOWER HEAD**

Bras | Arm

(Choisir la collection + le modèle | Choose the collection + the model)



**82V**



**83**



**84BC**



**84C**



**84L**



Pomme | Shower head



**281C**



**280C**



**284EP**



**280EP**



**281EP**



**286P**



**286**



**187**



**281R**



**280R**



**281T**



**288L**

**Ou | Or**

Plafond de douche | Sky shower

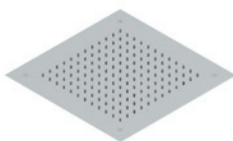

**493**

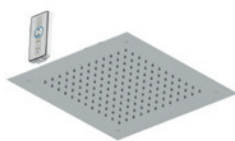

**491**

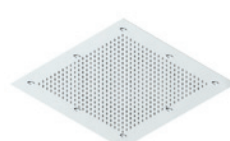

**487**



**490**



36

- x5** Miroir grossissant  
Magnifying mirror
- LED** Miroir éclairage LED  
Mirror with LED lighting
-  Branchement secteur  
Mains supply
- Classe 1 IPXX** Indice de protection  
Protection class



**G00.613IRB**

Distributeur de savon électronique à infrarouge  
Automatic liquid soap dispenser



**G00.669C**

Miroir mural éclairant grossissant  
Wall mounted magnifying illuminated mirror

- 
- LED**
- x5**
- Classe 1 IP21**





**G00.669**

Miroir mural éclairant grossissant

Wall mounted magnifying illuminated mirror



**LED**

**x5**

Classe 1  
**IP21**



**G00.669R**

Miroir mural éclairant grossissant

Wall mounted magnifying illuminated mirror



**LED**

**x5**

Classe 1  
**IP21**



37



Téléchargez notre catalogue miroirs sur notre site internet  
Download our mirror catalogue on our website

[WWW.THG-PARIS.COM](http://WWW.THG-PARIS.COM)



# COLLECTIONS - BECS DE LAVABO | BASIN SPOUT



G04.170  
Pure



G79.170  
Cubica



G5E.170  
Soho



U7G.170  
Icon-X



GIT.170  
Beluga



G6A.170  
Métamorphose



U4A.170  
Diplomate



A9F.170  
Jaipur



U2D.170  
Infini



U2M.170  
Nihal



G4P.170  
Collection «O»



G8A.170  
Les Ondes



G31.172  
Cygne



G24.170  
Amour de Trianon



G25.170  
1900



A35.170  
Bambou



G5A.170  
Nano



G7E.170  
Dean



G7A.170  
Beaubourg



G7C.170  
Saint-Germain



U2A.170  
Le 11



U93.170  
Malmaison



U9A.170  
West Coast



U9K.170  
Grand Central



G9A.170  
System Métal | Metal



G9C.170  
System Métal Diamant |  
Diamond Metal



G9E.170  
System Quadrillé Métal |  
Squared Metal



G9G.170  
System Howlite



G9J.170  
System Cristal | Crystal



U8D.170  
Corvair Métal | Metal



U8F.170  
Corvair Howlite



U8H.170  
Corvair Portoro



U8K.170  
Corvair Fior di Bosco



G2T.170  
Faubourg Métal | Metal



G69.170  
Spirit



G29.170  
Charleston



A54.170  
Art Déco

170E - 172E | 170V - 172V

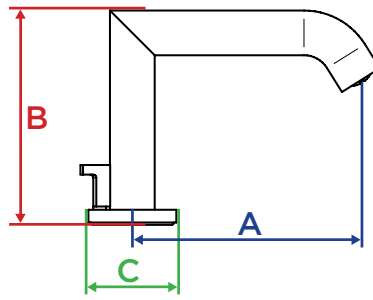

mm : millimètre  
inch : pouce

COLLECTIONS	REFERENCES	A		B		C	
		mm	inch	mm	inch	mm	inch
Pure	G04.170E   G04.170V	136	5 3/8"	208	8 1/4"	60 x 60	2 3/8" x 2 3/8"
Cubica	G79.170E   G79.170V	119	4 5/8"	168	6 5/8"	55 x 55	2 1/8" x 2 1/8"
Soho	G5E.170E   G5E.170V	179	7"	262	10 3/8"	50 x 50	2" x 2"
Icon-X	U7G.170E   U7G.170V	158	6 1/4"	220	8 5/8"	65 x 65	2 1/2" x 2 1/2"
Beluga	G1T.170E   G1T.170V	155	6 1/8"	131	5 1/8"	55 x 55	2 1/8" x 2 1/8"
Métamorphose	G6A.170E   G6A.170V	180	7 1/8"	246	9 3/4"	Ø 42	Ø 1 5/8"
Diplomate	U4A.170E   U4A.170V	136	5 3/8"	209	8 1/4"	Ø 60	Ø 2 3/8"
Jaipur	A9F.170E   A9F.170V	135	5 3/8"	208	8 1/4"	Ø 65	Ø 2 1/2"
Infini	U2D.170E   U2D.170V	135	5 3/8"	250	9 7/8"	42 x 60	1 5/8" x 2 3/8"
Nihal	U2M.170E   U2M.170V	113	4 1/2"	207	8 1/8"	60 x 47	2 3/8" x 1 7/8"
Collection "O"	G4P.170E   G4P.170V	160	6 1/4"	282	11 1/8"	Ø 60	Ø 2 3/8"
Les Ondes	G8A.170E   G8A.170V	160	6 1/4"	288	11 3/8"	Ø 57	Ø 2 1/4"
Cygne	G31.172E   G31.172V	227	8 7/8"	344	13 1/2"	Ø 67	Ø 2 5/8"
Amour de Trianon	G24.170E   G24.170V	142	5 5/8"	127	5"	Ø 72	Ø 2 7/8"
1900	G25.170E   G25.170V	200	7 7/8"	204	8"	Ø 55	Ø 2 1/8"
Bambou	A35.170E   A35.170V	143	5 5/8"	133	5 1/4"	Ø 55	Ø 2 1/8"
Nano	G5A.170E   G5A.170V	144	5 5/8"	130	5 1/8"	Ø 44	Ø 1 3/4"
	G5A.172E   G5A.172V	160	6 1/4"	282	11 1/8"	Ø 44	Ø 1 3/4"
Dean	G7E.170E   G7E.170V	180	7 1/8"	158	6 1/4"	Ø 55	Ø 2 1/8"
	G7E.172E   G7E.172V	150	5 7/8"	238	9 3/8"	Ø 55	Ø 2 1/8"
Beaubourg	G7A.170E   G7A.170V	150	5 7/8"	127	5"	Ø 60	Ø 2 3/8"
Saint-Germain	G7C.170E   G7C.170V	150	5 7/8"	129	5 1/8"	Ø 60	Ø 2 3/8"
Le 11	U2A.170E   U2A.170V	178	7"	143	5 5/8"	Ø 50	Ø 2"
Malmaison	U93.170E   U93.170V	163	6 3/8"	106	4 1/8"	Ø 65	Ø 2 1/2"
West Coast	U9A.170E   U9A.170V	140	5 1/2"	104	4 1/8"	Ø 60	Ø 2 3/8"
	U9A.172E   U9A.172V	150	5 7/8"	250	9 7/8"	Ø 60	Ø 2 3/8"
Grand Central	U9K.170E   U9K.170V	140	5 1/2"	104	4 1/8"	Ø 60	Ø 2 3/8"
	U9K.172E   U9K.172V	150	5 7/8"	250	9 7/8"	Ø 60	Ø 2 3/8"
System Métal	G9A.170E   G9A.170V	140	5 1/2"	102	4"	Ø 64	Ø 2 1/2"
	G9A.172E   G9A.172V	140	5 1/2"	173	6 3/4"	Ø 64	Ø 2 1/2"
System Métal Diamant	G9C.170E   G9C.170V	140	5 1/2"	102	4"	Ø 64	Ø 2 1/2"
	G9C.172E   G9C.172V	140	5 1/2"	173	6 3/4"	Ø 64	Ø 2 1/2"
System Métal Quadrillé	G9E.170E   G9E.170V	140	5 1/2"	102	4"	Ø 64	Ø 2 1/2"
	G9E.172E   G9E.172V	140	5 1/2"	173	6 3/4"	Ø 64	Ø 2 1/2"
System Howlite	G9G.170E   G9G.170V	140	5 1/2"	102	4"	Ø 64	Ø 2 1/2"
	G9G.172E   G9G.172V	140	5 1/2"	173	6 3/4"	Ø 64	Ø 2 1/2"
System Cristal	G9J.170E   G9J.170V	140	5 1/2"	102	4"	Ø 64	Ø 2 1/2"
	G9J.172E   G9J.172V	140	5 1/2"	173	6 3/4"	Ø 64	Ø 2 1/2"
Corvaire Métal	U8D.170E   U8D.170V	152	6"	93	3 5/8"	Ø 48	Ø 1 7/8"
Corvaire Howlite	U8F.170E   U8F.170V	152	6"	93	3 5/8"	Ø 48	Ø 1 7/8"
Corvaire Portoro	U8H.170E   U8H.170V	152	6"	93	3 5/8"	Ø 48	Ø 1 7/8"
Corvaire Fior di Bosco	U8K.170E   U8K.170V	152	6"	93	3 5/8"	Ø 48	Ø 1 7/8"
Faubourg Métal	G2T.170E   G2T.170V	140	5 1/2"	76	3"	Ø 60	Ø 2 3/8"
	G2T.172E   G2T.172V	151	6"	103	4 1/8"	Ø 60	Ø 2 3/8"
Spirit	G69.170E   G69.170V	140	5 1/2"	77	3"	Ø 55	Ø 2 1/8"
	G69.172E   G69.172V	151	6"	102	4"	Ø 55	Ø 2 1/8"
Charleston	G29.170E   G29.170V	142	5 5/8"	78	3 1/8"	Ø 64	Ø 2 1/2"
	G29.172E   G29.172V	148	5 3/4"	136	5 3/8"	Ø 54	Ø 2 1/8"
Art Déco	A54.170E   A54.170V	141	5 1/2"	81	3 1/4"	Ø 60	Ø 2 3/8"
	A54.172E   A54.172V	148	5 3/4"	143	5 5/8"	Ø 60	Ø 2 3/8"

# COLLECTIONS - BECS DE LAVABO INFRAROUGE | INFRARED BASIN SPOUTS



G79.170  
Cubica



G5E.170  
Soho



G1T.170  
Beluga



G8A.170  
Les Ondes



G6A.170  
Métamorphose



A9F.170  
Jaipur



U4A.170  
Diplomate



A35.170  
Bambou



G7E.170  
Dean



G7A.170  
Beaubourg



G7C.170  
Saint-Germain



U2A.170  
Le 11



G29.170  
Charleston



U93.170  
Malmaison



U9A.170  
West Coast



U9K.170  
Grand Central



G9A.170  
System Métal | Metal



G9C.170  
System Métal Diamant |  
Diamond Metal



G9E.170  
System Quadrillé Métal |  
Squared Metal



G9G.170  
System Howlite



G9J.170  
System Cristal | Crystal



A54.170  
Art Déco



170IRS | 170IRB

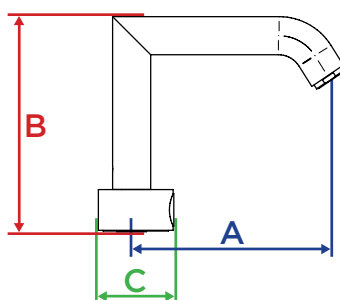

mm : millimètre  
inch : pouce

COLLECTIONS	REFERENCES	A		B		C	
		mm	inch	mm	inch	mm	inch
Cubica	G79.170IRS   G79.170IRB	119	4 5/8"	190	7 1/2"	50 x 50	2" x 2"
Soho	G5E.170IRS   G5E.170IRB	179	7"	291	11 1/2"	60 x 60	2 3/8" x 2 3/8"
Beluga	G1T.170IRS   G1T.170IRB	149	5 7/8"	153	6"	55 x 55	2 1/4" x 2 1/8"
Les Ondes	G8A.170IRS   G8A.170IRB	160	6 1/4"	298	11 3/4"	57 x 54	Ø 2 1/4"
Métamorphose	G6A.170IRS   G6A.170IRB	180	7 1/8"	276	10 7/8"	Ø 55	Ø 2 1/8"
Jaipur	A9F.170IRS   A9F.170IRB	136	5 3/8"	230	9 1/8"	Ø 55	Ø 2 1/8"
Diplomate	U4A.170IRS   U4A.170IRB	136	5 3/8"	231	9 1/8"	Ø 55	Ø 2 1/8"
Bambou	A35.170IRS   A35.170IRB	143	5 5/8"	157	6 1/8"	Ø 55	Ø 2 1/8"
Dean	G7E.170IRS   G7E.170IRB	150	5 7/8"	218	8 5/8"	Ø 55	Ø 2 1/8"
Beaubourg	G7A.170IRS   G7A.170IRB	200	7 7/8"	141	5 1/2"	Ø 55	Ø 2 1/8"
Saint-Germain	G7C.170IRS   G7C.170IRB	200	7 7/8"	141	5 1/2"	Ø 55	Ø 2 1/8"
Le 11	U2A.170IRS   U2A.170IRB	217	8 1/2"	167	6 5/8"	Ø 55	Ø 2 1/8"
Charleston	G29.170IRS   G29.170IRB	151	6"	166	6 1/2"	Ø 55	Ø 2 1/8"
Malmaison	U93.170IRS   U93.170IRB	163	6 3/8"	127	5"	Ø 64	Ø 2 1/2"
West Coast	U9A.170IRS   U9A.170IRB	150	5 7/8"	218	8 5/8"	Ø 55	Ø 2 1/8"
Grand Central	U9K.170IRS   U9K.170IRB	150	5 7/8"	218	8 5/8"	Ø 55	Ø 2 1/8"
System Métal	G9A.170IRS   G9A.170IRB	140	5 1/2"	127	5"	Ø 64	Ø 2 1/2"
System Métal Diamant	G9C.170IRS   G9C.170IRB	140	5 1/2"	127	5"	Ø 64	Ø 2 1/2"
System Métal Quadrillé	G9E.170IRS   G9E.170IRB	140	5 1/2"	127	5"	Ø 64	Ø 2 1/2"
System Howlite	G9G.170IRS   G9G.170IRB	140	5 1/2"	127	5"	Ø 64	Ø 2 1/2"
System Cristal	G9J.170IRS   G9J.170IRB	140	5 1/2"	127	5"	Ø 64	Ø 2 1/2"
Art Déco	A54.170IRS   A54.170IRB	151	6"	166	6 1/2"	Ø 55	Ø 2 1/8"

# COLLECTIONS - BECS DE LAVABO MURAUX | WALL MOUNTED BASIN SPOUTS



G04.22GAB  
Pure



G79.22GAB  
Cubica



U7G.22GAB  
Icon-X



G1T.22GAB  
Beluga



G6A.22GAB  
Métamorphose



U4A.22GAB  
Diplomate



A9F.22GAB  
Jaipur



U2D.22SGAB  
Infini



U2M.22SGAB  
Nihal



G4P.22GAB  
Collection «O»



G8A.22GAB  
Les Ondes



G25.22  
1900



A35.22GAB  
Bambou



G7E.22GAB  
Dean



G7A.22GAB  
Baubourg



G7C.22GAB  
Saint-Germain



U2A.22GAB  
Le 11



U9A.22GAB  
West Coast



U9K.22GAB  
Grand Central



G9A.22GAB  
System Métal | Metal



G9C.22GAB  
System Métal Diamant |  
Diamond Metal



G9E.22GAB  
System Quadrillé Métal |  
Squared Metal



G9G.22GAB  
System Howlite



G9J.22GAB  
System Cristal | Crystal



U8D.22SGAB  
Corvaire Métal | Metal



U8F.22SGAB  
Corvaire Howlite



U8H.22SGAB  
Corvaire Portoro



U8K.22SGAB  
Corvaire Fior di Bosco



G2T.22  
Faubourg Métal | Metal



G69.22  
Spirit



G29.22GAB  
Charleston



A54.22SGAB  
Art Déco

Retrouvez toutes nos collections sur | Find all our collections on  
WWW.THG-PARIS.COM

22 | 22GAB | 22SGAB

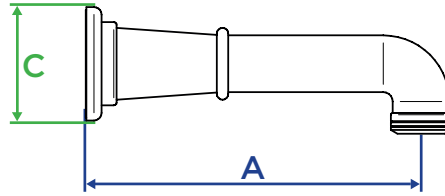

mm : millimètre  
inch : pouce

COLLECTIONS	REFERENCES	A		C	
		mm	inch	mm	inch
Pure	G04.22GAB	181	7"	45 x 45	1 ¾" x 1 ¾"
Cubica	G79.22GAB	190	7 ½"	70 x 70	2 ¾" x 2 ¾"
Icon-X	U7G.22GAB	170	6 ¾"	65 x 65	2 ½" x 2 ½"
Beluga	G1T.22GAB	135	5 ⅜"	55 x 55	2 ⅛" x 2 ⅛"
Métamorphose	G6A.22GAB	185	7 ¼"	Ø 50	Ø 2"
Diplomate	U4A.22GAB	188	7 ⅜"	Ø 65	Ø 2 ½"
Jaipur	A9F.22GAB	188	7 ⅜"	Ø 70	Ø 2 ¾"
Infini	U2D.22SGAB	219	8 ⅝"	Ø 53	Ø 2 ⅛"
Nihal	U2M.22SGAB	219	8 ⅝"	Ø 62	Ø 2 ⅜"
Collection «O»	G4P.22GAB	200	7 ⅞"	Ø 60	Ø 2 ⅜"
Les Ondes	G8A.22GAB	202	7 ⅞"	Ø 54	Ø 2 ⅛"
1900	G25.22	230	9"	Ø 55	Ø 2 ⅛"
Bambou	A35.22GAB	196	7 ¾"	Ø 70	Ø 2 ¾"
Dean	G7E.22GAB	183	7 ¼"	Ø 55	Ø 2 ⅛"
Beaubourg	G7A.22GAB	177	7"	Ø 60	Ø 2 ⅜"
Saint-Germain	G7C.22GAB	178	7"	Ø 60	Ø 2 ⅜"
Le 11	U2A.22GAB	163	6 ⅜"	Ø 50	Ø 2"
West Coast	U9A.22GAB	190	7 ½"	Ø 60	Ø 2 ⅜"
Grand Central	U9K.22GAB	190	7 ½"	Ø 60	Ø 2 ⅜"
System Métal	G9A.22GAB	203	8"	Ø 64	Ø 2 ½"
System Métal Diamant	G9C.22GAB	203	8"	Ø 64	Ø 2 ½"
System Métal Quadrillé	G9E.22GAB	203	8"	Ø 64	Ø 2 ½"
System Howlite	G9G.22GAB	203	8"	Ø 64	Ø 2 ½"
System Cristal	G9J.22GAB	203	8"	Ø 64	Ø 2 ½"
Corvair Métal	U8D.22SGAB	224	8 ⅞"	80 x 45	3 ⅛" x 1 ¾"
Corvair Howlite	U8F.22SGAB	224	8 ⅞"	80 x 45	3 ⅛" x 1 ¾"
Corvair Portoro	U8H.22SGAB	224	8 ⅞"	80 x 45	3 ⅛" x 1 ¾"
Corvair Fior di Bosco	U8K.22SGAB	224	8 ⅞"	80 x 45	3 ⅛" x 1 ¾"
Faubourg Métal	G2T.22	149	5 ⅞"	Ø 75	Ø 3"
Spirit	G69.22	148	5 ⅞"	Ø 65	Ø 2 ½"
Charleston	G29.22GAB	166	6 ½"	Ø 85	Ø 3 ⅜"
Art Déco	A54.22SGAB	213	8 ⅜"	Ø 65	Ø 2 ½"



# COLLECTIONS - BECS DE BAIN MURAUX | WALL MOUNTED BATH SPOUTS



G04.42GB G04.42SBG  
Pure



G79.42GB  
Cubica



G5E.42GB  
Soho



U7G.42SGB  
Icon-X



G1T.42GB G1T.42SBG  
Beluga



G6A.42GB G6A.42SBG  
Métamorphose



U4A.42GB U4A.42SBG  
Diplomate



A9F.42GB A9F.42SBG  
Jaipur



U2D.42SGB  
Infini



U2M.42SGB  
Nihal



G4P.42GB  
Collection «O»



G8A.42GB  
Les Ondes



G25.42GB  
1900



A35.42GB A35.42SBG  
Bambou



G5A.42GB  
Nano



G7E.42GB  
Dean



G7A.42GB G7A.42SBG  
Baubourg



G7C.42GB G7C.42SBG  
Saint-Germain



U2A.42SGB  
Le 11



U93.42GB  
Malmaison



U9A.42GB  
West Coast



U9K.42GB 42SBG  
Grand Central



G9A.42GB  
System Métal | Metal



G9C.42GB  
System Métal Diamant |  
Diamond Metal



G9E.42GB  
System Quadrillé Métal |  
Squared Metal



G9G.42GB  
System Howlite



G9J.42GB  
System Cristal | Crystal



U8D.42SGB  
Corvair Métal | Metal



U8F.42SGB  
Corvair Howlite



U8H.42SGB  
Corvair Portoro



U8K.42SGB  
Corvair Fior di Bosco



G2T.42SGB  
Faubourg Métal | Metal



G69.42SGB  
Spirit



G29.42GB G29.42SBG  
Charleston



A54.42SGB  
Art Déco

## 42GB | 42SGB

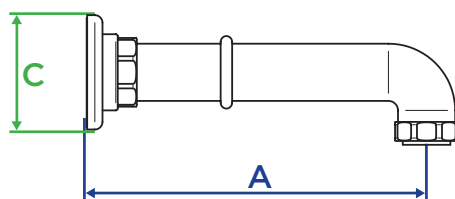

mm : millimètre  
inch : pouce

COLLECTIONS	REFERENCES	A		C	
		mm	inch	mm	inch
Pure	G04.42GB	181	7 1/8"	45 x 45	1 3/4" x 1 3/4"
	G04.42SGB	220	8 5/8"	50 x 50	2" x 2"
Cubica	G79.42GB	190	7 1/2"	70 x 70	2 3/4" x 2 3/4"
Soho	G5E.42GB	137	5 3/8"	50 x 50	2" x 2"
Icon-X	U7G.42SGB	216	8 1/2"	65 x 65	2 1/2" x 2 1/2"
Beluga	G1T.42GB	133	5 1/4"	55 x 55	2 1/8" x 2 1/8"
	G1T.42SGB	211	8 1/4"	60 x 60	2 3/8" x 2 3/8"
Métamorphose	G6A.42GB	185	7 1/4"	Ø 50	Ø 2"
	G6A.42SGB	225	8 7/8"	Ø 60	Ø 2 3/8"
Diplomate	U4A.42GB	188	7 3/8"	Ø 65	Ø 2 1/2"
	U4A.42SGB	229	9"	Ø 65	Ø 2 1/2"
Jaipur	A9F.42GB	188	7 3/8"	Ø 70	Ø 2 3/4"
	A9F.42SGB	229	9"	Ø 80	Ø 3 1/8"
Infini	U2D.42SGB	219	8 5/8"	53	Ø 2 1/8"
Nihal	U2M.42SGB	219	8 5/8"	61	2 3/8"
Collection «O»	G4P.42GB	202	8"	Ø 60	Ø 2 3/8"
Les Ondes	G8A.42GB	204	8"	Ø 54	Ø 2 1/8"
1900	G25.42GB	261	10 1/4"	Ø 84	Ø 3 1/4"
Bambou	A35.42GB	196	7 3/4"	Ø 70	Ø 2 3/4"
	A35.42SGB	203	8"	Ø 70	Ø 2 3/4"
Nano	G5A.42GB	190	7 1/2"	Ø 44	Ø 1 3/4"
Dean	G7E.42GB	183	7 1/4"	Ø 55	Ø 2 1/8"
Beaubourg	G7A.42GB	177	7"	Ø 60	Ø 2 3/8"
	G7A.42SGB	227	8 7/8"	Ø 60	Ø 2 3/8"
Saint-Germain	G7C.42GB	178	7"	Ø 60	Ø 2 3/8"
	G7C.42SGB	228	9"	Ø 60	Ø 2 3/8"
Le 11	U2A.42SGB	203	8"	Ø 50	Ø 2"
Malmaison	U93.42GB	223	8 3/4"	Ø 60	Ø 2 3/8"
West Coast	U9A.42GB	190	7 1/2"	Ø 60	Ø 2 3/8"
Grand Central	U9K.42GB	190	7 1/2"	Ø 60	Ø 2 3/8"
	U9K.42SGB	207	8 1/8"	Ø 75	Ø 3"
System Métal	G9A.42GB	203	8"	Ø 64	Ø 2 1/2"
System Métal Diamant	G9C.42GB	203	8"	Ø 64	Ø 2 1/2"
System Métal Quadrillé	G9E.42GB	203	8"	Ø 64	Ø 2 1/2"
System Howlite	G9G.42GB	203	8"	Ø 64	Ø 2 1/2"
System Cristal	G9J.42GB	203	8"	Ø 64	Ø 2 1/2"
Corvair Métal	U8D.42SGB	224	8 7/8"	80 x 45	3 1/8" x 1 3/4"
Corvair Howlite	U8F.42SGB	224	8 7/8"	80 x 45	3 1/8" x 1 3/4"
Corvair Portoro	U8H.42SGB	224	8 7/8"	80 x 45	3 1/8" x 1 3/4"
Corvair Fior di Bosco	U8K.42SGB	224	8 7/8"	80 x 45	3 1/8" x 1 3/4"
Faubourg Métal	G2T.42SGB	239	9 3/8"	Ø 75	Ø 3"
Spirit	G69.42SGB	238	9 3/8"	Ø 65	Ø 2 1/2"
Charleston	G29.42GB	166	6 1/2"	Ø 85	Ø 3 3/8"
	G29.42SGB	221	8 3/4"	Ø 85	Ø 3 3/8"
Art Déco	A54.42SGB	213	8 3/8"	Ø 65	Ø 2 1/2"

# COLLECTIONS - BECS DE BAIN | BATH SPOUTS



G04.29  
Pure



G79.29  
Cubica



G5E.29SG  
Soho



U7G.29SG  
Icon-X



G1T.29  
Beluga



G6A.29  
Métamorphose



U4A.29SG  
Diplomate



A9F.29SG  
Jaipur



U2D.29SG  
Infini



U2M.29SG  
Nihal



G4P.29SG  
Collection «O»



G25.29SG  
1900



G8A.29SG  
Les Ondes



A35.29SG  
Bambou



G5A.29SGB G5A.29SGH  
Nano



G7E.29SGB G7E.29SGH  
Dean



G7A.29SG  
Baubourg



G7C.29SG  
Saint-Germain



U2A.29SG  
Le 11



U93.29  
Malmaison



U9A.29SGB U9A.29SGH  
West Coast



U9K.29SGB U9K.29SGH  
Grand Central



G9A.29 G9A.29H  
System Métal | Metal



G9C.29 G9C.29H  
System Métal Diamant |  
Diamond Metal



G9E.29 G9E.29H  
System Quadrillé Métal |  
Squared Metal



G9G.29 G9G.29H  
System Howlite



G9J.29 G9J.29H  
System Cristal | Crystal



U8D.29SG  
Corvair Métal | Metal



U8F.29SG  
Corvair Howlite



U8H.29SG  
Corvair Portoro



U8K.29SG  
Corvair Fior di Bosco



G2T.29SG  
Faubourg Métal | Metal



G69.29SG  
Spirit



G29.29SGB G29.SGH  
Charleston

46

Retrouvez toutes nos collections sur | Find all our collections on  
[WWW.THG-PARIS.COM](http://WWW.THG-PARIS.COM)



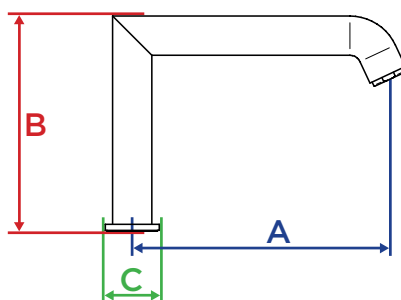

mm : millimètre  
inch : pouce

COLLECTIONS	REFERENCES	A		B		C	
		mm	inch	mm	inch	mm	inch
Pure	G04.29	179	7"	230	9"	50 x 55	2" x 2 1/8"
Cubica	G79.29	171	6 3/4"	202	8"	60 x 60	2 3/8" x 2 3/8"
Soho	G5E.29SG	179	7"	262	10 3/8"	50 x 50	2" x 2"
Icon-X	U7G.29SG	171	6 3/4"	221	8 5/8"	65 x 65	2 1/2" x 2 1/2"
Beluga	G1T.29	192	7 1/2"	183	7 1/4"	65 x 65	2 1/2" x 2 1/2"
Métamorphose	G6A.29	180	7 1/8"	246	9 5/8"	Ø 50	Ø 2"
Diplomate	U4A.29SG	166	6 1/2"	245	9 5/8"	Ø 65	Ø 2 1/5"
Jaipur	A9F.29SG	166	6 1/2"	245	9 5/8"	Ø 70	Ø 2 3/4"
Infini	U2D.29SG	180	7 1/8"	273	10 3/4"	40 x 60	1 5/8" x 2 3/8"
Nihal	U2M.29SG	156	6 1/8"	270	10 5/8"	73 x 66	2 7/8" x 2 5/8"
Collection «O»	G4P.29SG	215	8 1/2"	352	13 7/8"	Ø 60	Ø 2 3/8"
1900	G25.29SG	220	8 5/8"	234	9 1/4"	Ø 70	Ø 2 3/4"
Les Ondes	G8A.29SG	215	8 1/2"	352	13 7/8"	Ø 57	Ø 2 1/4"
Bambou	A35.29SG	210	8 1/4"	181	7 1/8"	Ø 65	Ø 2 1/2"
Nano	G5A.29SGB	210	8 1/4"	175	6 7/8"	Ø 50	Ø 2"
	G5A.29SGH	215	8 1/2"	316	12 1/2"	Ø 50	Ø 2"
Dean	G7E.29SGB	220	8 5/8"	155	6 1/8"	Ø 55	Ø 2 1/8"
	G7E.29SGH	180	7 1/8"	285	11 1/4"	Ø 55	Ø 2 1/8"
Beaubourg	G7A.29SG	200	7 7/8"	127	5"	Ø 60	Ø 2 3/8"
Saint-Germain	G7C.29SG	200	7 7/8"	129	5 1/8"	Ø 60	Ø 2 3/8"
Le 11	U2A.29SG	191	7 1/5"	145	5 3/4"	Ø 50	Ø 2"
Malmaison	U93.29	163	6 3/8"	106	4 1/8"	Ø 65	Ø 2 1/2"
West Coast	U9A.29SGB	220	8 5/8"	126	5"	Ø 75	Ø 3"
	U9A.29SGH	180	7 1/8"	298	11 3/4"	Ø 60	Ø 2 3/8"
Grand Central	U9K.29SGB	220	8 5/8"	126	5"	Ø 75	Ø 3"
	U9K.29SGH	180	7 1/8"	298	11 3/4"	Ø 60	Ø 2 3/8"
System Métal	G9A.29	201	7 7/8"	96	3 3/4"	Ø 64	Ø 2 1/2"
	G9A.29H	201	7 7/8"	168	6 5/8"	Ø 64	Ø 2 1/2"
System Métal Diamant	G9C.29	201	7 7/8"	96	3 3/4"	Ø 64	Ø 2 1/2"
	G9C.29H	201	7 7/8"	168	6 5/8"	Ø 64	Ø 2 1/2"
System Métal Quadrillé	G9E.29	201	7 7/8"	96	3 3/4"	Ø 64	Ø 2 1/2"
	G9E.29H	201	7 7/8"	168	6 5/8"	Ø 64	Ø 2 1/2"
System Howlite	G9G.29	201	7 7/8"	96	3 3/4"	Ø 64	Ø 2 1/2"
	G9G.29H	201	7 7/8"	168	6 5/8"	Ø 64	Ø 2 1/2"
System Cristal	G9J.29	201	7 7/8"	96	3 3/4"	Ø 64	Ø 2 1/2"
	G9J.29H	201	7 7/8"	168	6 5/8"	Ø 64	Ø 2 1/2"
Corvair Métal	U8D.29SG	220	8 5/8"	102	4"	55	2 1/8"
Corvair Howlite	U8F.29SG	220	8 5/8"	102	4"	55	2 1/8"
Corvair Portoro	U8H.29SG	220	8 5/8"	102	4"	55	2 1/8"
Corvair Fior di Bosco	U8K.29SG	220	8 5/8"	102	4"	55	2 1/8"
Faubourg Métal	G2T.29SG	220	8 5/8"	116	4 5/8"	Ø 60	Ø 2 3/8"
Spirit	G69.29SG	220	8 5/8"	115	4 1/2"	Ø 55	Ø 2 1/8"
Charleston	G29.29SGB	225	8 7/8"	101	4"	Ø 66	Ø 2 5/8"
	G29.29SGH	235	9 1/4"	180	7 1/8"	Ø 60	Ø 2 3/8"

## FINITIONS | FINISHES

Plus de finitions disponibles sur [WWW.THG-PARIS.COM](http://WWW.THG-PARIS.COM)

For more finishes and additional information, please visit [WWW.THG-PARIS.COM](http://WWW.THG-PARIS.COM)

### TRAITEMENTS CLASSIQUES | STANDARD TREATMENTS



**A02**  
Chrome  
Polished chrome



**B01**  
Nickel  
Polished nickel



**C01**  
Nickel mat  
Matt nickel



**H03**  
Vieil argent  
verniss brillant  
Lacquered  
antique silver



**F30**  
Or pâle  
Soft gold



**F31**  
Or pâle mat  
Soft matt gold



**F01**  
Doré  
Polished gold



**F07**  
Doré mat  
Matt gold



**D01**  
Bronze clair  
verniss brillant  
Lacquered  
light bronze



**D05**  
Bronze clair  
verniss mat  
Lacquered  
matt bronze

### TRAITEMENTS PVD | PVD TREATMENTS

48



**H55**  
PVD couleur  
nickel  
Nickel color  
PVD



**H56**  
PVD couleur  
nickel mat  
Matt nickel  
color PVD



**H64**  
PVD graphite  
Graphite PVD



**H65**  
PVD graphite  
mat  
Matt graphite  
PVD



**H49**  
PVD couleur  
laiton  
Brass color  
PVD



**H50**  
PVD couleur  
laiton mat  
Matt brass  
color PVD



**H52**  
PVD couleur  
doré  
Gold color  
PVD



**H53**  
PVD couleur  
doré mat  
Matt gold  
color PVD



**H62**  
PVD blush  
Blush PVD



**H60**  
PVD blush mat  
Matt blush  
PVD



**H66**  
PVD umber  
Umber PVD



**H67**  
PVD umber  
mat  
Matt umber  
PVD



**F33**  
PVD couleur  
bronze brown  
Bronze brown  
color PVD



**F34**  
PVD couleur  
bronze brown mat  
Matt brown  
bronze color PVD

# CONTACT

## SIÈGE SOCIAL | HEAD OFFICE

### THG FRANCE

35, rue Tournière - BP 80212  
Béthencourt-sur-Mer  
80535 Friville cedex - France  
+33 (0)3 22 60 20 80  
contact@thg.fr  
www.thg-paris.com

## FILIALES | SUBSIDIARIES

### THG USA LLC

Head office  
441 NW - 1<sup>st</sup> avenue  
Fort Lauderdale  
FL 33301 - USA  
Tel. +1 954 425 8225  
info@thgusa.com

### THG DEUTSCHLAND GMBH

Gutleutstr. 96  
60329 Frankfurt/Main  
Deutschland  
Tel. +49 (0)69/ 25 78 14 33  
info@thg-deutschland.de

### THG UK

11 Commercial Way,  
London NW10 7XF  
United Kingdom  
Tel. +44 (0)20 8202 8288  
salesuk@thg-paris.com

### THG ASIA

7/F Building 11,  
Phase II Zhong Jun Plaza,  
1688 Shenchang Road,  
Shanghai (PRC)  
上海市闵行区申长路1688弄中骏广场二期11号楼7楼  
电话/ Tel. +86 (21) 613 527 38  
contact@thg-asia.cn

### THG RUSSIA

Leningradskiy avenue,  
bld. 37A, housing 14  
125167 Moscow - Russia  
Tel. +7 495 800 8225  
thg@thg-russia.ru

### THG MIDDLE EAST

Alan Haddad  
Dubai Design District  
Building 3, Office 605  
Dubai, UAE  
Tel. +971 508 456 003  
contact@thg-paris.com

## SHOWROOMS THG | THG SHOWROOMS

### PARIS

152 bd Haussmann  
75008 Paris - France  
Tel. +33 (0)1 44 20 09 20  
contact@thg-bathconcept.com  
www.thg-bathconcept.com

### LONDON

4 Pont Street  
London SW1X 9EL  
United Kingdom  
Tel. +44 (0)20 7838 7788  
salesuk@thg-paris.com  
london.thg-paris.com

### NEW YORK

D&D Building  
Showroom 1206 - 12th floor  
979 Third Avenue - New-York  
NY 10022 - USA  
Tel. +1 (917) 242 8911  
info@thgusa.com

### FRANKFURT

Gutleutstr. 96  
60329 Frankfurt/Main  
Deutschland  
Tel. +49 (0)69/ 25 78 14 33  
info@thg-deutschland.de

## CRÉDITS | CREDITS

### CONCEPTION ET RÉALISATION

THG Paris

### IMPRESSION

Jean Bernard

Textes et photos non contractuels et susceptibles d'être modifiés sans préavis |  
Text and pictures are not binding and can be modified without any previous notice

© THG Paris Avril 2022





**THG<sup>®</sup>**  
P A R I S