



THG[®]
P A R I S

ZOOM

BY WILMOTTE





Fondée en 1956, THG Paris est une entreprise française spécialisée dans la conception et la fabrication de robinetteries et accessoires de salle de bain haut de gamme.



Présente dans plus de 60 pays, THG Paris est une société de dimension internationale avec 8 filiales dans le monde (Londres, Paris, Moscou, New York, Shanghai, Dubai, Singapour et Milan). Cette présence permet d'accompagner la clientèle à travers le monde, notamment avec des produits répondant aux normes spécifiques de chaque pays.

La maîtrise complète du process de conception et de production en interne permet à THG Paris d'offrir des solutions et design innovants. Des designers renommés collaborent régulièrement avec THG Paris pour sa capacité à concrétiser leurs projets avec un haut niveau de détail et de qualité. Notre savoir-faire permet toutes les réalisations sur mesure. De nombreuses collections et projets ont été développés entre autres avec Jamie Drake, Gilles & Emissie, Martin Kemp et encore Charles Zana.

THG Paris est spécialisée près de 100 ans en Normandie, concentrent l'ensemble des savoirs faire nécessaires à la fabrication de nos produits. Cette maîtrise est reconnue par le label EPV qui honore les entreprises de tradition et de fabrication française, gageur de l'excellence française. Ce haut niveau d'exigence est partagé avec nos partenaires de prestige : Lalique, Baccarat, Christofle ou Haviland.

Soucieux d'offrir des solutions complètes et coordonnées, tant dans les designs que les finitions, THG Paris élargit son offre au fil des années et propose des produits complémentaires comme la robinetterie de cuisine, les produits électroniques ou les poignées de porte.



David Bonnelle
CEO THG Paris

Founded in 1956, THG Paris is a French company specialising in the design and manufacture of luxury bathroom fittings and accessories.

Established in over 60 countries, THG Paris is an international company with 8 branches worldwide (London, Paris, Moscow, New York, Shanghai, Dubai, Singapore and Milan). THG Paris's international presence allows us to support our customers all around the world, including country-specific products.

THG Paris controls the entire design and production process internally in order to offer highly innovative solutions and designs. Renowned for our attention to detail and high-quality products, distinguished designers regularly collaborate and entrust us with the realisation of their projects. Thanks to our expertise, we are able to offer a wide variety of custom-made products. We have developed many different collections and projects alongside designers such as Jamie Drake, Gilles & Emissie, Martin Kemp and Charles Zana, among others.

The THG Paris workshops situated near the coast of Normandy are home to both the expertise and resource required to manufacture our products. In recognition of this, THG Paris has received the prestigious EPV label, awarded to companies who demonstrate excellence in their traditional and industrial skills. It is a guarantee of exceptional French manufacturing. These high standards are shared by our partners such as: Lalique, Baccarat, Christofle and Haviland.

Offering complete and coordinated solutions, both in terms of design and finish, THG Paris has broadened its product offering over the years to include complementary products such as kitchen taps, electronic solutions, and door handles.

ZOOM

BY WILMOTTE

THE
PARIS

MOOS

BY WILMOTTE



Fondée en 1956, THG Paris est une entreprise française spécialisée dans la conception et la fabrication de robinetteries et accessoires de salles de bain haut de gamme.

Présente dans plus de 60 pays, THG Paris est une société de dimension internationale avec 8 filiales dans le monde (Londres, Paris, Moscou, New York, Shanghai, Dubai, Singapour et Milan). Cette présence permet d'accompagner la clientèle à travers le monde, notamment avec des produits répondant aux normes spécifiques de chaque pays.

La maîtrise complète du processus de conception et de production en interne permet à THG Paris d'offrir des solutions et designs innovants. Des designers renommés collaborent régulièrement avec THG Paris pour sa capacité à concrétiser leurs projets avec un haut niveau de détail et de qualité. Notre savoir-faire permet toutes les réalisations sur-mesure. De nombreuses collections et projets ont été développés entre autres avec : Jamie Drake, Gilles & Boissier, Martin Kemp ou encore Charles Zana.

Les ateliers THG Paris, localisés près des côtes de Normandie, concentrent l'ensemble des savoirs faire nécessaires à la fabrication de nos produits. Cette maîtrise est reconnue par le label EPV qui honore les entreprises de tradition et de fabrication française, gage de l'excellence française. Ce haut niveau d'exigence est partagé avec nos partenaires tels que : Lalique, Baccarat, Christofle ou Haviland.

Soucieux d'offrir des solutions complètes et coordonnées, tant dans les designs que les finitions, THG Paris élargit son offre au fil des années et propose des produits complémentaires comme la robinetterie de cuisine, les produits électroniques ou les poignées de porte.

Founded in 1956, THG Paris is a French company specialising in the design and manufacture of luxury bathroom fittings and accessories.

Established in over 60 countries, THG Paris is an international company with 8 branches worldwide (London, Paris, Moscow, New York, Shanghai, Dubai, Singapore and Milan). THG Paris's international presence allows us to support our customers all around the world, including country-specific products.

THG Paris controls the entire design and production process internally in order to offer highly innovative solutions and designs. Renowned for our attention to detail and high-quality products, distinguished designers regularly collaborate and entrust us with the realisation of their projects. Thanks to our expertise, we are able to offer a wide variety of custom-made products. We have developed many different collections and projects alongside designers such as Jamie Drake, Gilles & Boissier, Martin Kemp and Charles Zana, among others.

The THG Paris workshops situated near the coast of Normandy are home to both the expertise and resource required to manufacture our products. In recognition of this, THG Paris has received the prestigious EPV label, awarded to companies who demonstrate excellence in their traditional and industrial skills. It is a guarantee of exceptional French manufacturing. These high standards are shared by our partners such as: Lalique, Baccarat, Christofle and Haviland.

Offering complete and coordinated solutions, both in terms of design and finish, THG Paris has broadened its product offering over the years to include complementary products such as kitchen taps, electronic solutions, and door handles.

A handwritten signature in black ink, appearing to read 'David Bonnelle'.

David Bonnelle
CEO THG Paris

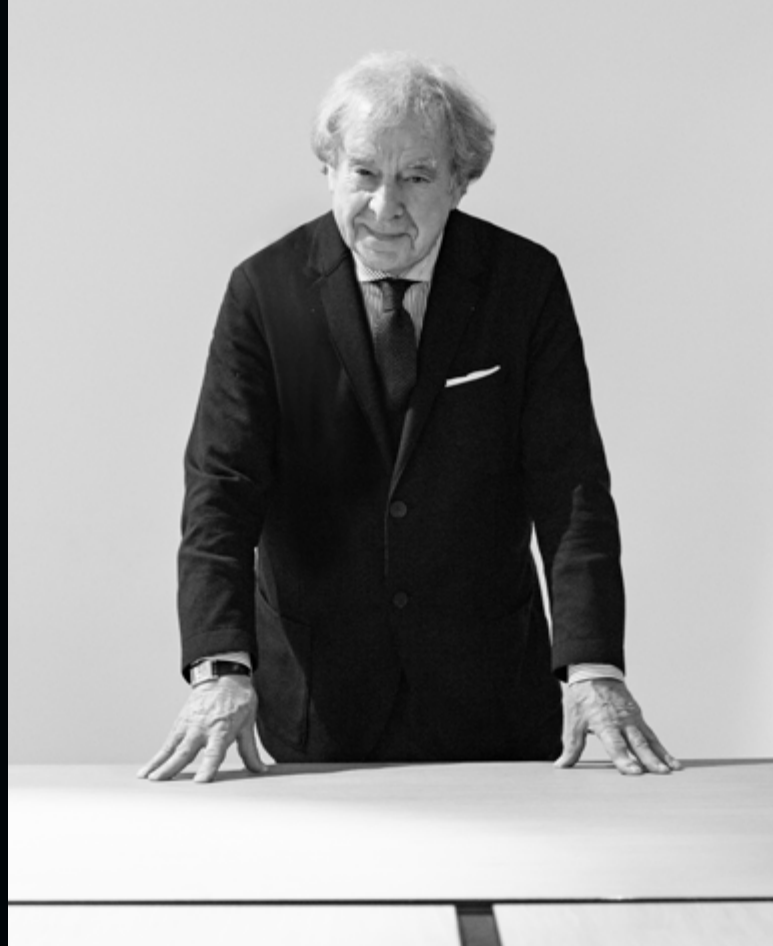

2

// Observer, capter les subtilités du monde et les transcender : un état d'esprit et ma ligne de conduite au quotidien.

Observing, capturing the subtleties of the world and transcending them: this is my state of mind and my guiding principle on a daily basis.

//

Jean-Michel Wilmotte

Architecte, urbaniste et designer français, Jean-Michel Wilmotte est né en 1948. Il a créé sa propre agence d'architecture à Paris en 1975.

Depuis, il n'a de cesse de développer et de diversifier ses savoir-faire, en France et à l'étranger.

Renommée pour l'éclectisme de sa production, l'élégance et la qualité de finition de ses projets, l'agence Wilmotte est présente dans les secteurs public et privé, dans le luxe, l'hôtellerie, le résidentiel et le tertiaire. Elle fédère 270 collaborateurs de 31 nationalités différentes, et oeuvre dans 23 pays.

Comme un prolongement naturel des projets de l'agence d'architecture, Jean-Michel Wilmotte a fondé le studio de design Wilmotte & Industries.

Depuis 45 ans, il s'est construit une véritable réputation dans le monde du design industriel et d'objets en collaborant avec de nombreux éditeurs et industriels dans le monde entier et notamment en France.

En rapprochant les forces créatives « made in France », Jean Michel Wilmotte favorise le développement et le rayonnement des manufactures françaises.

Au sein de son studio, il s'attache à reprendre ses propres codes architecturaux avec des lignes sobres et épurées, amenant ainsi un caractère chic et intemporel à ses collections.

French architect, urban planner, and designer Jean-Michel Wilmotte was born in 1948. He established his own architecture firm in Paris in 1975.

Since then, he has continuously expanded and diversified his expertise, both in France and abroad.

Founded by Jean-Michel Wilmotte, The Wilmotte Agency operates in the public and private sectors, spanning luxury, hospitality, residential, and tertiary domains. It brings together 270 employees from 31 different nationalities and operates in 23 countries delivering the renowned eclecticism of Jean-Michel Wilmotte's work, adding elegance and quality of finish to projects.

As a natural extension of the architectural projects of the agency, Jean-Michel Wilmotte also founded the design studio Wilmotte & Industries.

Over the past 45 years, he has built a true reputation in the world of industrial and object design by collaborating with numerous publishers and manufacturers worldwide.

By bringing together the creative forces "made in France", Jean Michel Wilmotte is promoting the development and influence of French manufacturers.

In his studio, he uses his own architectural codes with clean, simple lines, giving his collections a chic, timeless character.

ZOOM.5.7.12

La collection ZOOM trouve son origine dans les lignes et les formes d'une grande précision, empruntées à l'univers de la photographie. Elle reflète la passion de Jean-Michel Wilmotte pour cet art et témoigne de son goût prononcé pour le sens du détail et de l'assemblage méticuleux des pièces mécaniques. La gravure, la vis et la géométrie sont fidèles à son ADN et révèlent tout le savoir-faire de l'architecte : exigence, excellence et précision.

Conçu tel un bijou de précision, ZOOM se matérialise tout d'abord par deux bagues qui se fondent en une seule entité. Un jeu de négatif et de positif qui, ensemble, créent une forme. L'une est marquée par la gravure, l'autre par un polissage méticuleux. Tandis que l'une demeure statique, l'autre évoque le mouvement. Entre ces deux bagues, se dessine subtilement un jeu de lignes, révélateur de nuances. C'est un véritable laboratoire créatif où l'esthétique et la fonction ne font qu'un, fusionnant harmonieusement.

The ZOOM Collection was inspired by the highly precise lines and shapes found in the world of photography. It reflects Jean-Michel Wilmotte's passion for this form of art and testifies to his pronounced attention to detail and the meticulous assembly of mechanical parts. The engraving and the geometry are faithful to his inherent disposition for exacting standards, excellence and precision.

Designed like a precise jewel, ZOOM begins with two rings that merge into a single entity. A play of negative and positive that together create a shape. One is engraved, the other meticulously polished. While one remains static, the other evokes movement. Between these two rings, a subtle interplay of lines emerges, revealing nuances. It's a creative laboratory where aesthetics and function become one, merging harmoniously.



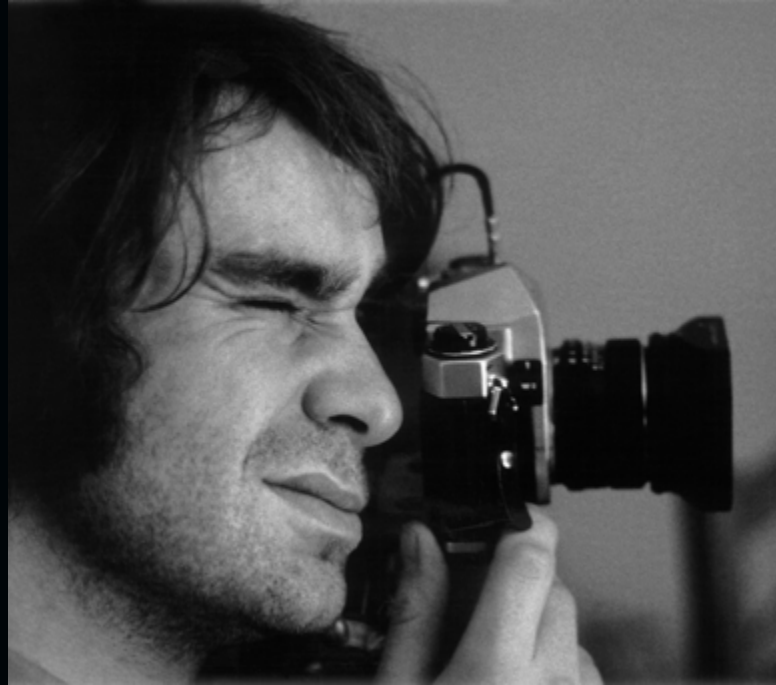

//

Ma passion pour la photographie et les détails liés à cet univers m'ont inspiré pour créer cette ligne de robinetterie chic et contemporaine.

My passion for photography and the details linked to this world inspired me to create this line of chic, contemporary taps.

//

Jean-Michel Wilmotte

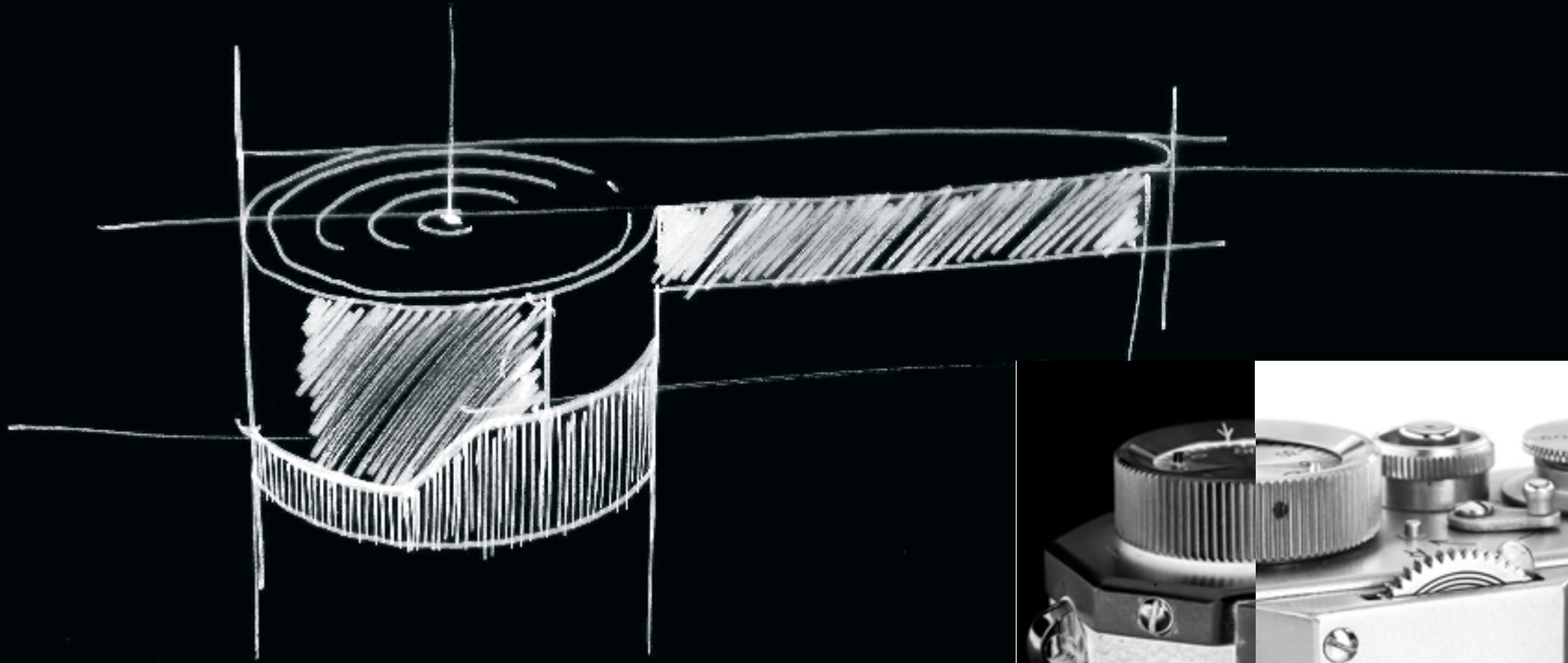

Handwritten signature or mark in the bottom right corner of the lens image.

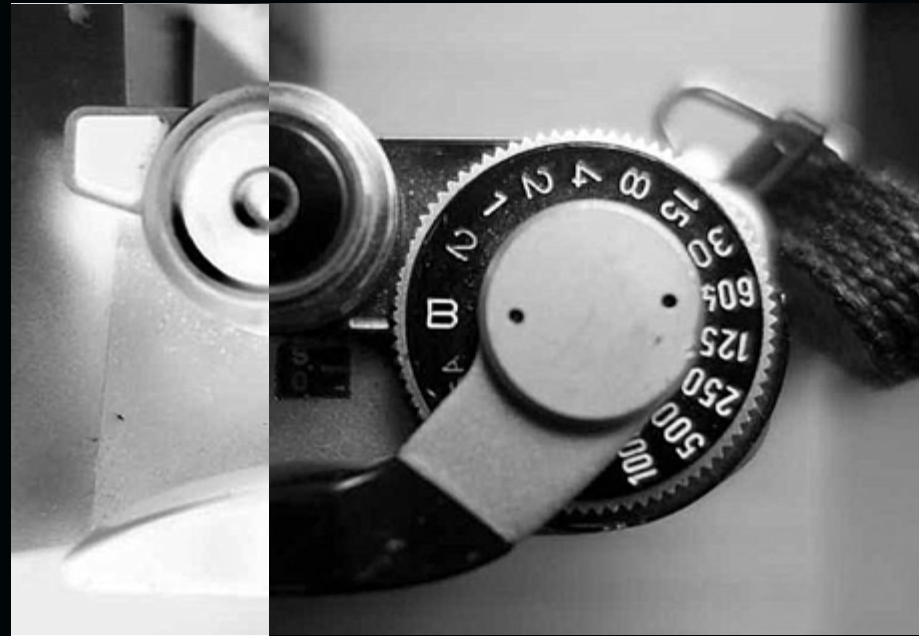
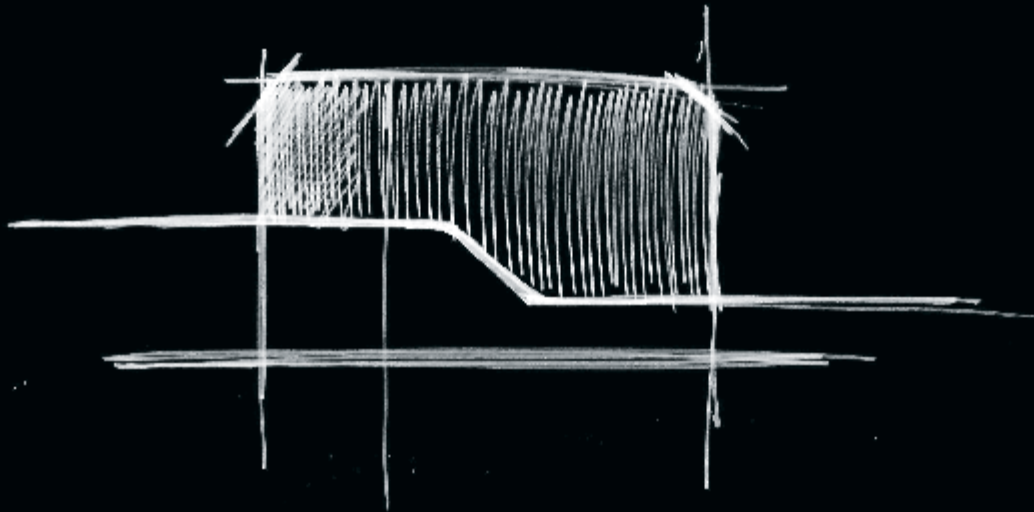
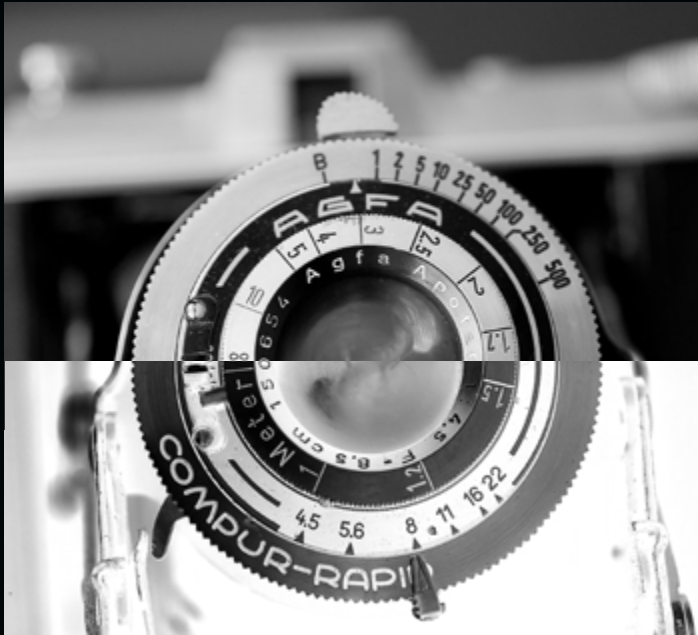

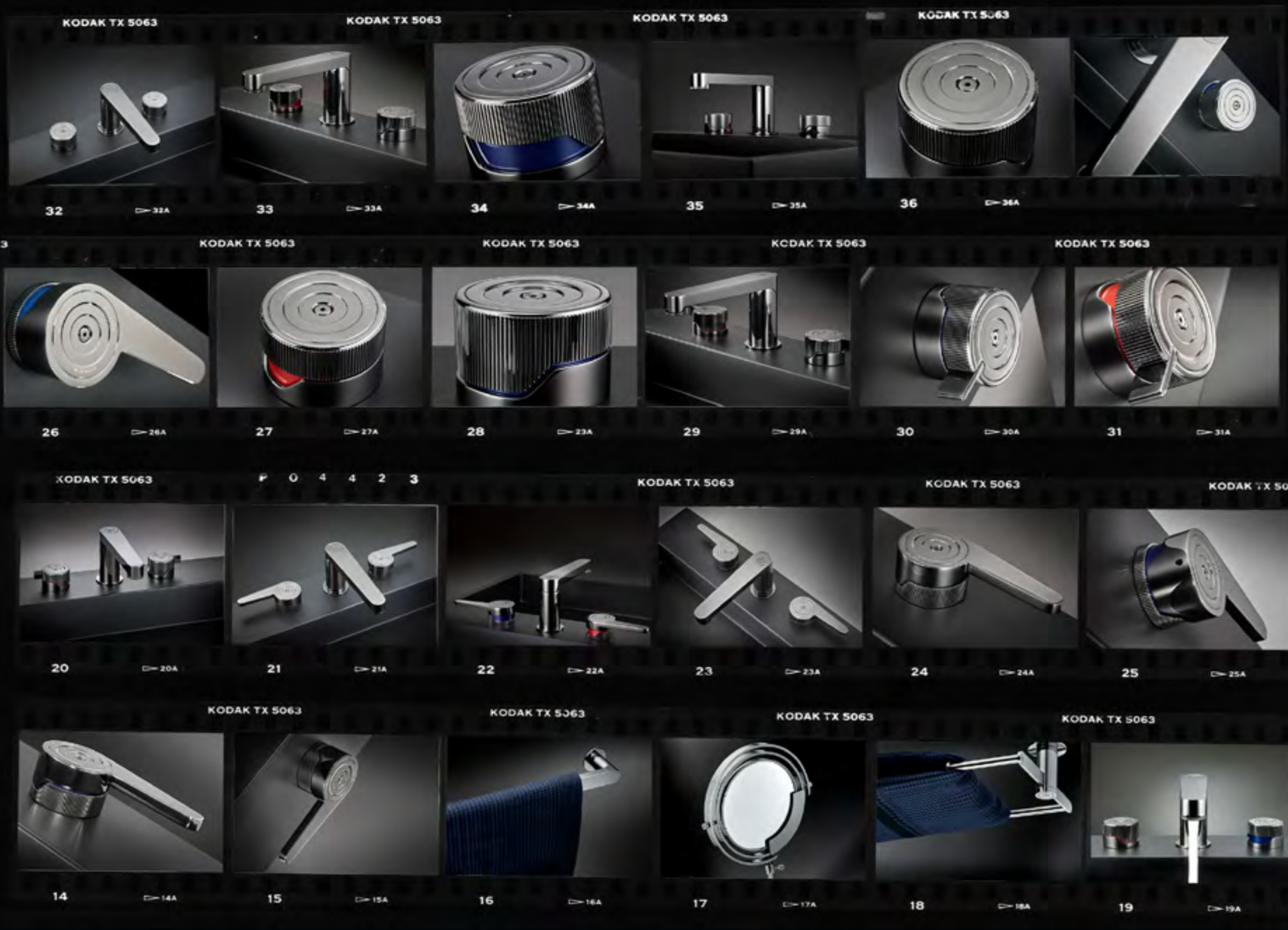

F 0 4 4 2 3

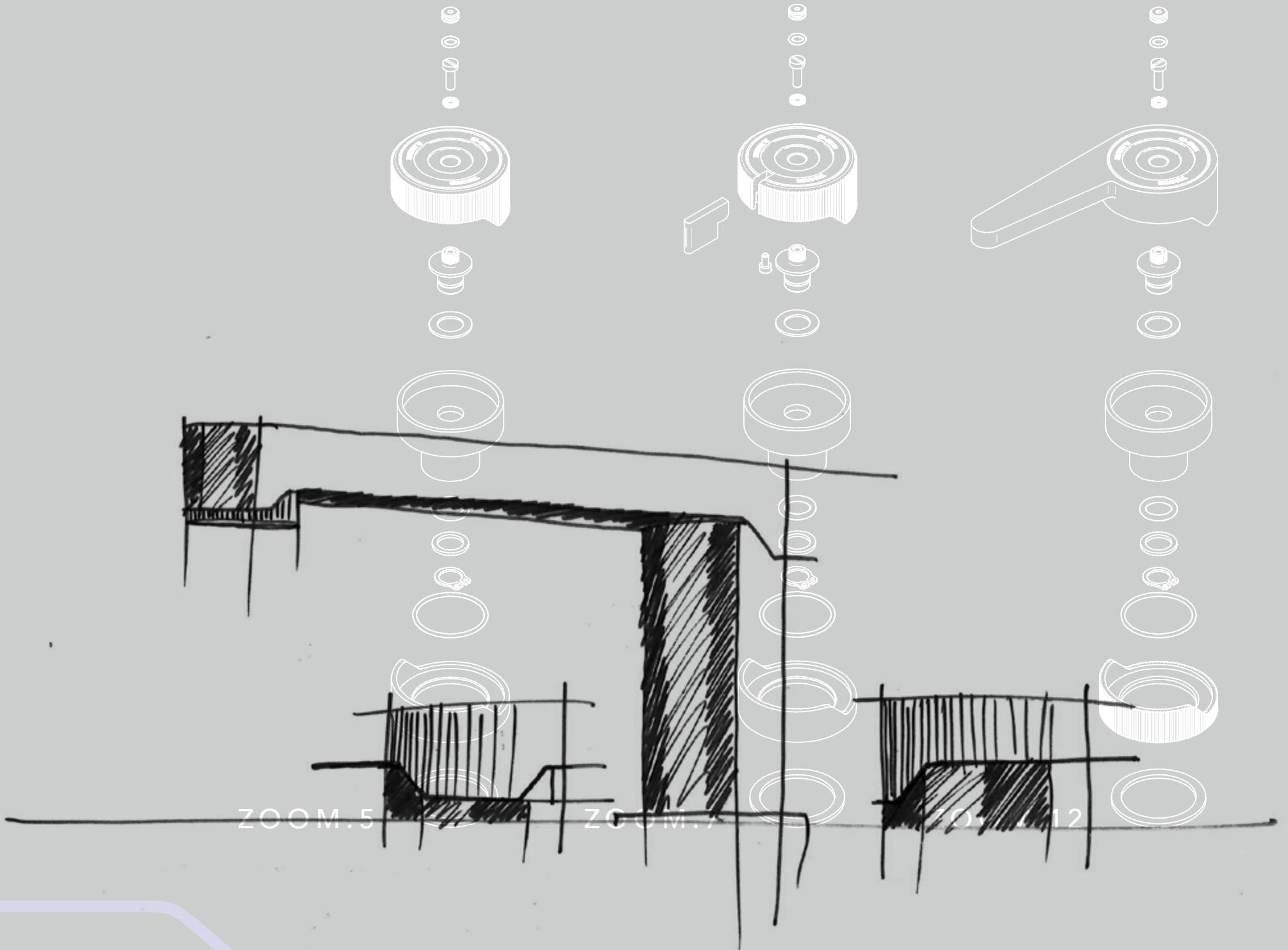

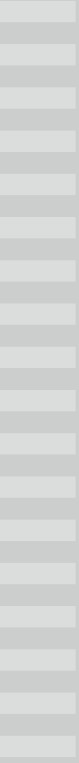

4



KODAK TX 5063

KODAK TX 5063

KODAK TX 5063

KODAK TX 5063

32 D=32A

33 D=33A

34 D=34A

35 D=35A

36 D=36A



KODAK TX 5063

KODAK TX 5063

KODAK TX 5063

KODAK TX 5063

26 D=26A

27 D=27A

28 D=28A

29 D=29A

30 D=30A

31 D=31A



KODAK TX 5063

P O 4 4 2 3

KODAK TX 5063

KODAK TX 5063

KODAK TX 5063

20 D=20A

21 D=21A

22 D=22A

23 D=23A

24 D=24A

25 D=25A

KODAK TX 5063

KODAK

KODAK TX 5063

KODAK TX 5063

14 D=14A

15 D=15A

17 D=17A

18 D=18A

19 D=19A

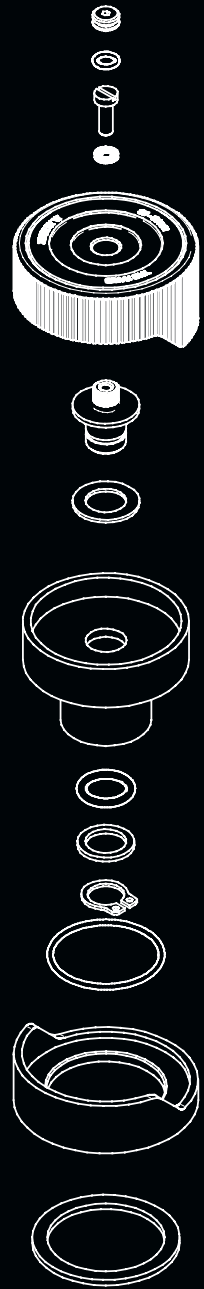

ZOOM.5

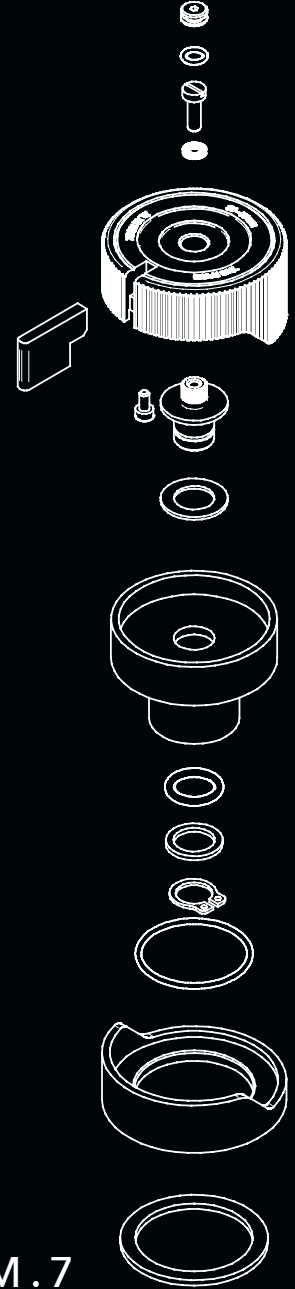

ZOOM.7

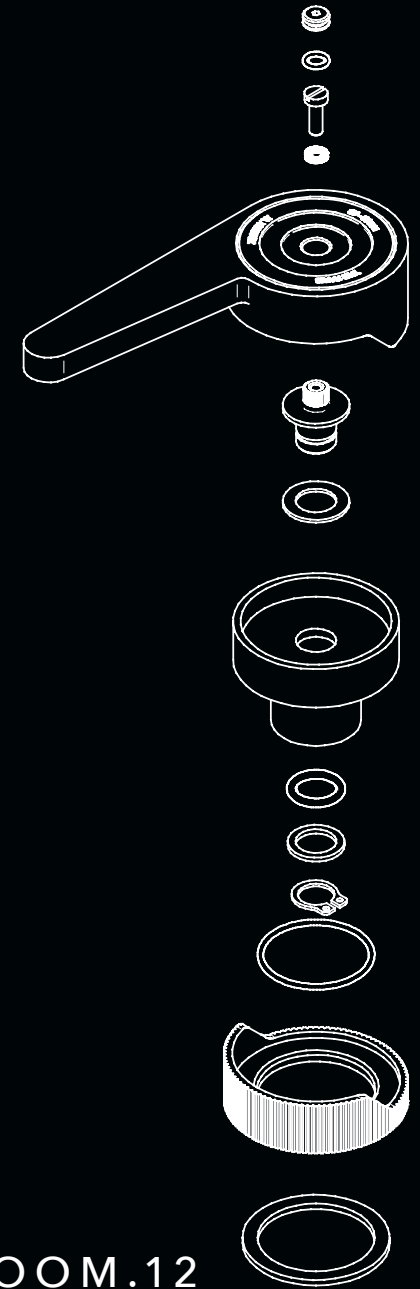

ZOOM.12





10

ZOOM . 5























ZOOM . 7



















ZOOM.12







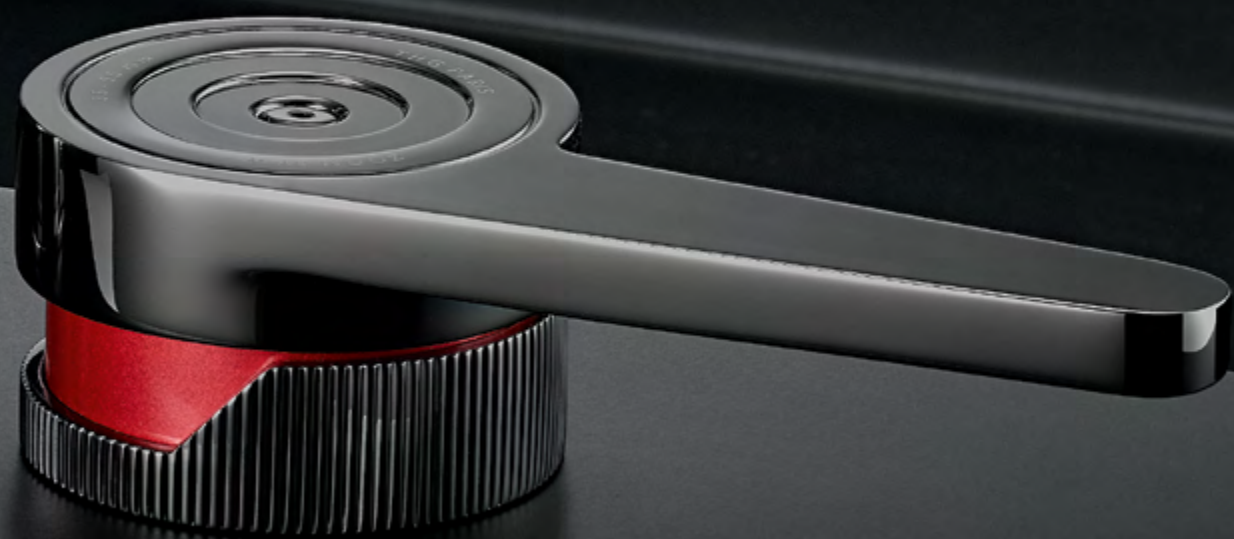









ZOOM | APERÇU DES COLLECTIONS | COLLECTIONS OVERVIEW

ZOOM.5



U4J.151
Mélangeur de lavabo avec vidage
Basin mixer with waste

ZOOM.7



U4K.151
Mélangeur de lavabo avec vidage
Basin mixer with waste

ZOOM.12



U4L.151
Mélangeur de lavabo avec vidage
Basin mixer with waste



U4J.152
Mélangeur de lavabo avec vidage, bec haut
Basin mixer with waste, high spout



U4K.152
Mélangeur de lavabo avec vidage, bec haut
Basin mixer with waste, high spout



U4L.152
Mélangeur de lavabo avec vidage, bec haut
Basin mixer with waste, high spout

ZOOM | MITIGEURS | MIXERS

U4J - U4K - U4L



6500
Mitigeur de lavabo avec vidage
Single lever basin mixer with waste



6541BT + 5840/MA
Ensemble mitigeur de lavabo mural,
bec tube
Wall mounted basin mixer set,
tube spout



6541B + 5840/MA
Ensemble mitigeur de lavabo mural
Wall mounted basin mixer set

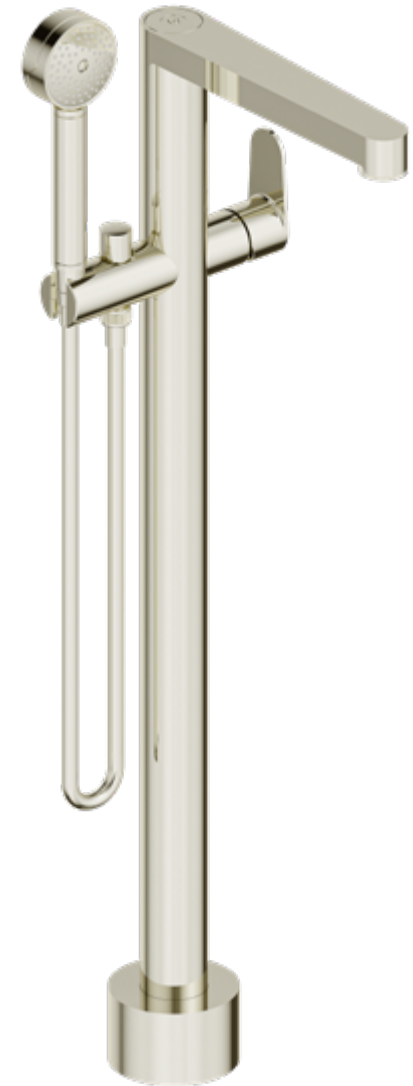

6508S
Mitigeur bain/douche sur colonne
Free-standing bath/shower mixer



5840MBG + 5840/MA
Ensemble hygiénique alimenté par
mitigeur
WC douche set with single lever mixer



6504
Mitigeur de bidet avec vidage
Single lever bidet mixer with waste



6561B + 5840/MA
Ensemble douchette murale alimentée
par mitigeur
Wall mounted handshower set supplied
by mixer

ZOOM.5 | PRODUITS ASSOCIÉS | ASSOCIATED PRODUCTS



U4J.40GB + 40AC
Ensemble mélangeur de lavabo mural
Wall mounted basin mixer set



U4J.41GBT + 40AC
Ensemble mélangeur de bain mural,
bec tube
Wall mounted bath mixer set, tube spout



U4J.1132SG
Mélangeur de bain et douchette alimentée par mitigeur
Bath mixer and handshower supplied by mixer



U4J.25SG
Mélangeur de bain
Bath mixer



U4J.25SGH
Mélangeur de bain, bec haut
Bath mixer, high spout



U4J.5400BE + 5400AE
Ensemble
thermostatique
avec 2 robinets d'arrêt
THG thermostat set
with 2 valves



U4J.5500BE + 5500AE
Ensemble
thermostatique avec
inverseur 2 sorties
THG thermostat set
with 2-way diverter



U4J.5100B + 5200AE
Ensemble
thermostatique
THG thermostat set

ZOOM.7 | PRODUITS ASSOCIÉS | ASSOCIATED PRODUCTS



U4K.112BSGBH
Mélangeur de bain avec douchette, bec haut
Bath mixer with handshower, high spout



U4K.1132SG
Mélangeur de bain et douchette
alimentée par mitigeur
Bath mixer and handshower supplied
by mixer

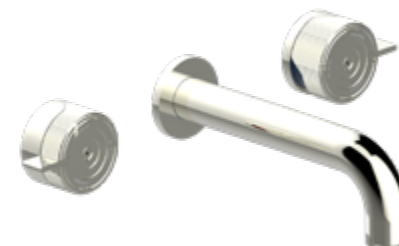

U4K.41GBT + 40AM
Ensemble mélangeur de bain mural,
bec tube
Wall mounted bath mixer set, tube spout



U4K.40GB + 40AM
Ensemble mélangeur de lavabo mural
Wall mounted basin mixer set



U4K.5500BE + 5500AE
Ensemble thermostatique
avec inverseur 2 sorties
THG thermostat set with 2-way diverter



U4K.5540BE + 5540AE
Ensemble thermostatique 3 fonctions
THG thermostat set with 3 functions

ZOOM.12 | PRODUITS ASSOCIÉS | ASSOCIATED PRODUCTS



U4L.6590
Mitigeur de lavabo avec vidage
Basin mixer with waste



U4L.40GB + 40AM
Ensemble mélangeur de lavabo mural
Wall mounted basin mixer set



U4L.1132SG
Mélangeur de bain et douchette alimentée par mitigeur
Bath mixer and handshower supplied by mixer



U4L.41GBT + 40AM
Ensemble mélangeur de bain mural,
bec tube
Wall mounted bath mixer set, tube spout



U4L.112BSGBH
Mélangeur de bain avec douchette,
bec haut
Bath mixer with handshower, high spout



U4L.5401BEH + 5401AHM
Ensemble thermostatique
avec 2 robinets d'arrêt
THG thermostat set with 2 valves



U4L.5300BE + 5300AE
Ensemble thermostatique avec
robinet d'arrêt
THG thermostat set with stop valve

DOUCHE | SHOWER



84L
Bras pour pomme de
douche long. 450 mm
Wall mounted shower
arm, length: 450 mm



3641
Lame d'eau murale
Wall-mounted shower
water blade



54T
Ensemble douchette avec
tablette
Handshower set with
shelf



280EP
Pomme de douche 300
mm, système Easyclean
Shower head 300 mm,
Easyclean system



281EP
Pomme de douche 200
mm, système Easyclean
Shower head 200 mm,
Easyclean system



54
Ensemble douchette
Handshower set



290/J
Jet latéral
Jet



290/M
Jet brumisateur
Soft mist jet

58
Ensemble douchette
avec barre
Handshower set
with slidebar



SÈCHE-SERVIETTES | TOWEL WARMERS



B6B.TWR1E
Sèche-serviette 1 barre,
électrique
Towel warmer 1 rail,
electric



B6B.TWR3H
Sèche-serviette 3 barres,
hydraulique
Towel warmer 3 rails,
hydronic



B6B.TWR6E
Sèche-serviette 6 barres,
électrique
Towel warmer 6 rails,
electric

BAIGNOIRES ET VASQUES | BATHTUBS AND BASINS



B11.B571 MONCEAU
Baignoire à poser
Free-standing bathtub



B11.B591 MONCEAU
Baignoire à poser
Free-standing bathtub



B10.B660 TWIN
Baignoire à encastrer
Built-in bathtub



B13.V590 MONCEAU
Vasque à poser
On counter basin



B13.V523 SHADE
Vasque à poser
On counter basin



GB2.V400SS
Vasque à poser - Inox brossé
On counter basin - Brushed
stainless steel
Autres coloris disponibles
Other finishes availables



651L
Miroir mural Ø 1m
Wall mounted mirror Ø 1m



659
Miroir mural grossissant
éclairage LED
Wall mounted magnifying led
illuminated mirror



658
Miroir à poser double face
Free-standing mirror, reversible

ZOOM | ACCESSOIRES | ACCESSORIES

U4J - U4K - U4L



514/30 - 514/45 - 514/60
Porte-serviette, longueur 30, 45, 60 cm
Single towel rail, length 30, 45, 60 cm



26BP
Bouton moyen modèle
Medium door knob



26BT
Bouton petit modèle
Small door knob

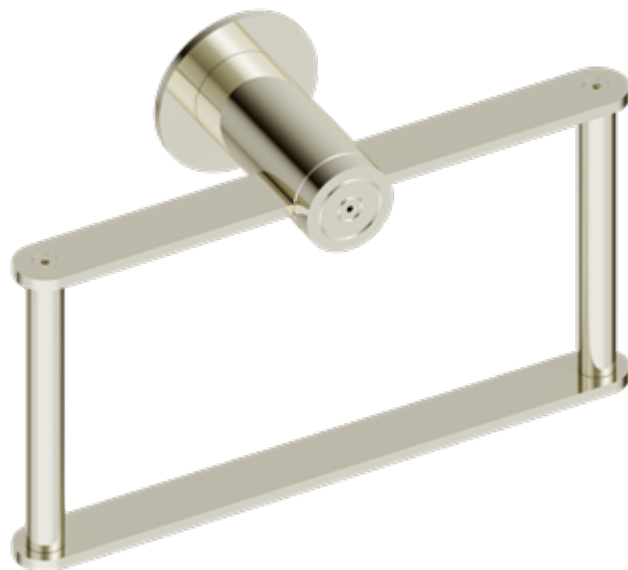

504N
Anneau porte-serviette
Towel ring



538A
Porte-papier
WC paper holder



517
Porte-peignoir
Robe hook

FINITIONS FINISHES

TRAITEMENTS CLASSIQUES STANDARD TREATMENTS



A02
Chrome
Polished chrome



B01
Nickel
Polished nickel



C01
Nickel mat
Matt nickel



D30
Noir céramique
Black ceram



F30
Or pâle
Soft gold



F31
Or pâle mat
Soft matt gold



F01
Doré
Polished gold



F07
Doré mat
Matt gold



D01
Bronze clair vernis brillant
Lacquered light bronze



D05
Bronze clair vernis mat
Lacquered matt bronze

TRAITEMENTS PVD PVD TREATMENTS



H55
PVD couleur nickel
Nickel color PVD



H56
PVD couleur nickel mat
Matt nickel color PVD



H64
PVD couleur graphite
Graphite color PVD



H65
PVD couleur graphite mat
Matt graphite color PVD



H52
PVD couleur doré
Gold color PVD



H53
PVD couleur doré mat
Matt gold color PVD



H49
PVD couleur laiton
Brass color PVD



H50
PVD couleur laiton mat
Matt brass color PVD



F33
PVD couleur
bronze brown
Bronze brown
color PVD



F34
PVD couleur
bronze brown mat
Matt brown
bronze color PVD



H62
PVD couleur blush
Blush color PVD



H60
PVD couleur blush mat
Matt blush color PVD



H66
PVD couleur umber
Umber color PVD



H67
PVD couleur umber mat
Matt umber color PVD

CONTACT

SIÈGE SOCIAL HEAD OFFICE

THG FRANCE
35, rue Tournière - BP 80212
80130 Béthencourt-sur-Mer
France
+33 (0)3 22 60 20 80
contact@thg.fr
www.thg-paris.com

FILIALES SUBSIDIARIES

THG USA LLC
Head office
441 NW - 1st avenue
Fort Lauderdale
FL 33301 - USA
Tel. +1 954 425 8225
info@thgusa.com

THG UK
11 Commercial Way,
London NW10 7XF
United Kingdom
Tel. +44 (0)20 8202 8288
salesuk@thg-paris.com

THG SINGAPORE
Est. THG Paris Pte. Ltd.
541 Orchard Road,
#09-01 Liat Towers,
Singapore 238881,
Singapore
Tel. +65 8181 5064
rshuen@thg-paris.com

THG RUSSIA
Leningradskiy avenue,
bld. 37A, housing 14
125167 Moscow - Russia
Tel. +7 495 800 8225
thg@thg-russia.ru

THG ASIA
7/F Building 11, Phase II
Zhong Jun Plaza,
1688 Shenchang Road,
Minhang District,
Shanghai - PRC
上海市闵行区申长路
1688弄中骏广场二期11号楼7楼
电话/ Tel. +86 (21) 613 527 38
contact@thg-asia.cn

SHOWROOMS THG PARIS THG PARIS SHOWROOMS

PARIS
152 bd Haussmann
75008 Paris - France
Tel. +33 (0)1 44 20 09 20
contact@thg-bathconcept.com
www.thg-bathconcept.com

LONDON
Unit 2 Design Centre North,
1Harbour Avenue
London SW10 OHG
United Kingdom
Tel. +44 (0)20 7838 7788
salesuk@thg-paris.com

NEW YORK
D&D Building
Showroom 1206 - 12th floor
979 Third Avenue - New-York
NY 10022 - USA
Tel. +1 (917) 242 8911
info@thgusa.com

FRANKFURT
Gutleutstr. 96
60329 Frankfurt/Main
Deutschland
Tel. +49 (0)69/ 25 78 14 33
kontakt@thg-paris.com

DUBAI
Dubai Design District
Building 1A, Office 404
Dubai - UAE
Tel. +971 4 580 5716
contact.me@thg-paris.com

MILANO
Brera district
Via Fiori Chiari 5
20121 Milano
thgitaly@thg-paris.com

CRÉDITS CREDITS

CONCEPTION ET RÉALISATION

THG Paris

DIRECTION ARTISTIQUE |

ART DIRECTION

Studio de Design W&I

DESIGN TEAM

Soline Rouland,
Hugo Charpy-Puget

PHOTOS INTRODUCTION

P. 2 : © Jean Grisoni,
P. 4 : © Keiichi Tahara,
P. 5 : © D. R. (Archives fam. Wilmotte)

PHOTOS CATALOGUE

© Didier Grieu

IMPRESSION

Imprimerie Jean Bernard

REMERCIEMENTS

Le Jacquard français

Textes et photos non contractuels
et susceptibles d'être modifiés
sans préavis

Text and pictures are not binding
and can be modified without any
previous notice



Entreprise
du Patrimoine
Vivant

L'excellence
des savoir-faire
français



@wilmotte_industries
www.wilmotte.com

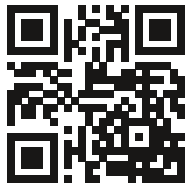



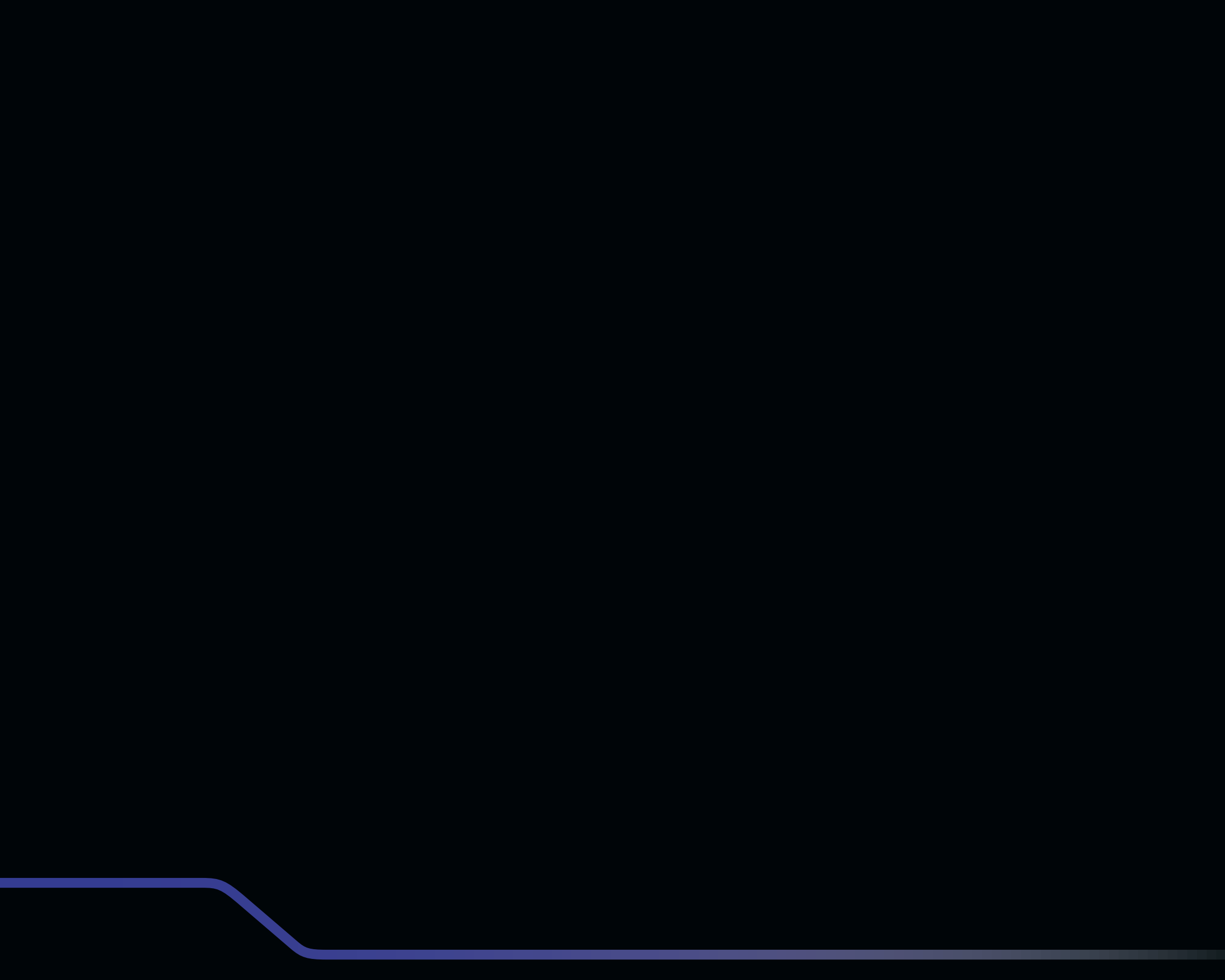

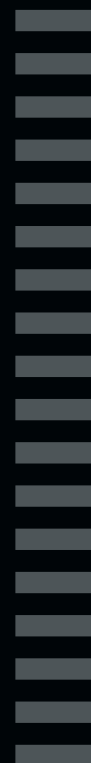

THG[®]
P A R I S

THG-PARIS.COM

