

ICON-X

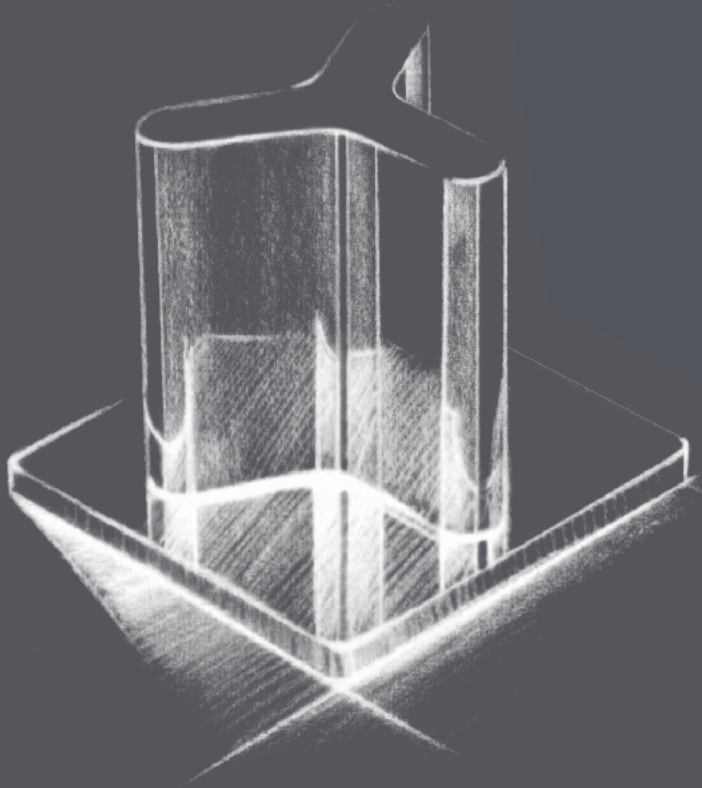

Design by
STUDIO F·A·PORSCHE

THG[®]
P A R I S

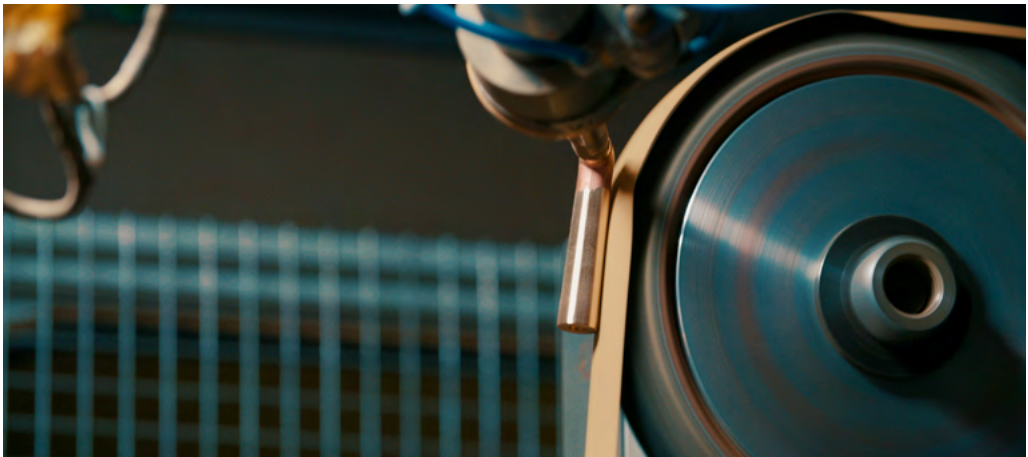



En tant que fabricant français de robinetteries et d'accessoires de bain, la maison THG Paris évoque à la fois l'artisanat et l'industrie française à son plus haut niveau. Nous imaginons, développons et fabriquons nos produits depuis 1956.

Grâce à notre savoir-faire unique, nous proposons des produits d'exception pour la salle de bain, dont l'excellence permet à THG Paris de mériter son appellation de « Haute Couture de la robinetterie ».

Depuis plus de 60 ans, THG Paris a pour vocation d'enrichir le design de la salle de bain en offrant des modèles de robinetteries aux styles bien différents. À la fois esthétiques et techniques, les produits THG Paris répondent aux exigences et aux normes des pays du monde entier.

MICHEL GOSSE
Vice-Président
Vice President

As a French manufacturer of bathroom fittings and accessories, THG Paris evokes both master craftsmanship and industry at its highest level. We have been imagining, developing and manufacturing our products since 1956.

With our unique know-how, we offer exceptional products for the bathroom, whose excellence allows THG Paris to deserve its "Haute Couture of bathroom fittings" name.

For over 60 years, THG Paris has been enhancing bathroom design by offering models of bathroom fittings in very different styles. Both aesthetically pleasing and of high technical quality, THG Paris products comply with the requirements and standards prevailing in all countries around the world.

STUDIO F·A·PORSCHE

2



Le design doit être honnête - ces mots prononcés par le fondateur, Ferdinand Alexander Porsche, sont au cœur de notre réflexion. Ils signifient que le design n'est pas simplement décoration ou embellissement superficiel, mais plutôt la symbiose parfaite de la forme et de la fonction. Cela n'est possible qu'après avoir bien compris les fonctionnalités d'un produit.

Après avoir travaillé dans l'entreprise automobile familiale en tant que concepteur, Ferdinand Alexander a décidé de se faire un prénom. En quelques années, il a relevé le défi avec son agence de design Studio F. A. Porsche. Ses produits sont rapidement devenus des classiques intemporels du design.

Aujourd'hui, le studio conçoit des produits et développe des stratégies de marque pour des clients du monde entier ainsi que pour sa propre marque de style de vie exclusive : Porsche Design.



Ferdinand Alexander Porsche

Good design must be honest – these words spoken by the founder, Ferdinand Alexander Porsche, get to the heart of our thinking. They mean that design is not simply decoration or superficial beautification, but rather the perfect symbiosis of form and function. This can only be achieved once you have fully grasped the functionality of a product.

After working in the family-owned car company as designer for years, Ferdinand Alexander set out to make a name of himself. In just a few years, he rose to the challenge with his very own design agency Studio F. A. Porsche. His products quickly became timeless design classics.

Today, the studio designs products and develops brand strategies for clients worldwide as well as for its own exclusive lifestyle brand Porsche Design.

ICON-X

GOOD DESIGN MUST BE HONEST...

4 **Prof. Ferdinand Alexander Porsche**

La philosophie du Professeur Ferdinand Alexander Porsche, illustrant la symbiose entre fonctionnalité et design, n'a jamais autant résonné qu'avec cette nouvelle collection de robinetterie, un chef-d'œuvre d'ingénierie par essence.

Mélange de lignes fluides et tendues, insertion de matériaux spécifiques, THG Paris a relevé avec brio le challenge proposé par le Studio F. A. Porsche.

Ainsi, ICON-X incarne les valeurs communes des deux Maisons, et propose une expérience fonctionnelle et sensitive, un Art de Vivre revendiqué.

La signature : un design affirmé et intemporel, au-delà des tendances.

Professor Ferdinand Alexander Porsche's philosophy, illustrating the symbiosis between functionality and design, has never resonated as much as with this new collection of fittings, an engineering in essence.

Mixture of fluid and taut lines, the use of specific materials, THG Paris has brilliantly met the challenge proposed by Studio F. A. Porsche.

Thus, ICON-X alone embodies the shared values of the two Houses, and offers a functional and sensitive experience, a claimed Art de Vivre.

The signature: an assertive and timeless design that goes beyond trends.

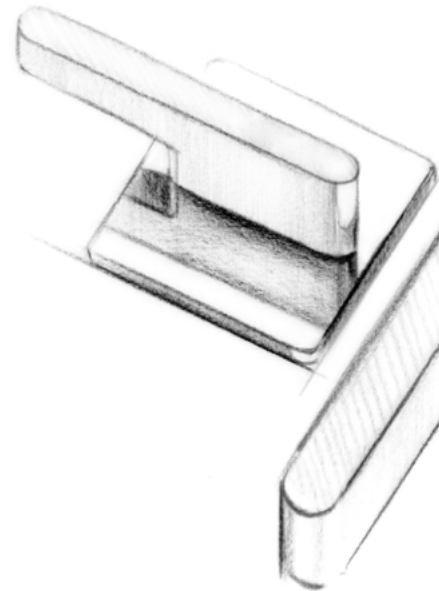

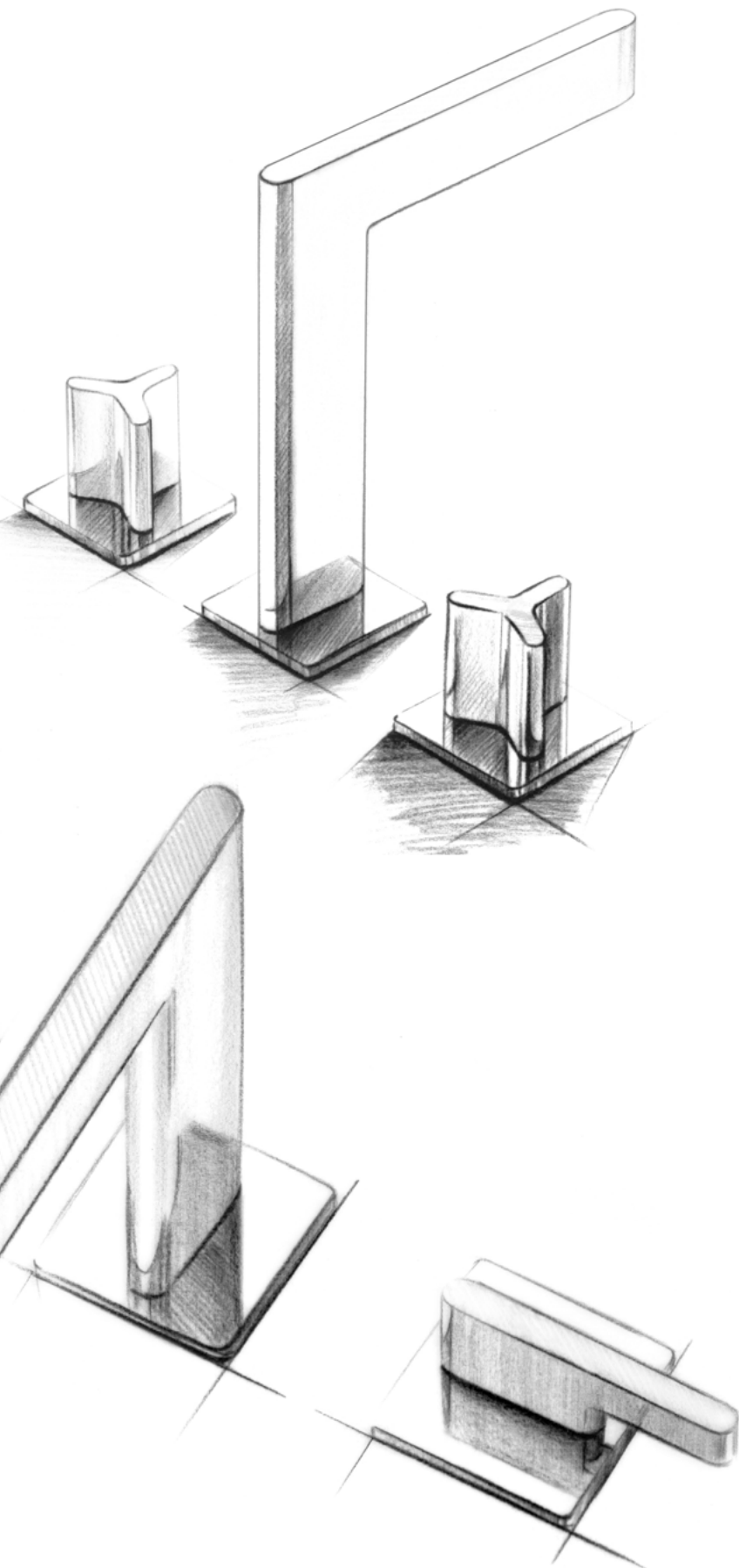

ICON-X RÉCOMPENSÉE PAR LE PRIX « PRODUCT DESIGN 2021 ».

Concours mondial prestigieux, faisant référence dans l'univers du design, Red Dot Design Award met en lumière les concepts de design les plus innovants depuis 1995. Chaque année, son jury d'experts internationaux distingue ainsi des objets spécialement esthétiques, fonctionnels, intelligents ou innovants. Leur point commun ? Une qualité de conception exceptionnelle.

ICON-X RECEIVES THE "PRODUCT DESIGN 2021" AWARD.

The Red Dot Design Award is a prestigious worldwide competition that rewards the most innovative design concepts since 1995. Each year, its jury of international experts distinguish objects that are especially aesthetic, functional, intelligent or innovative. What do they have in common? Exceptional design quality.



reddot winner 2021

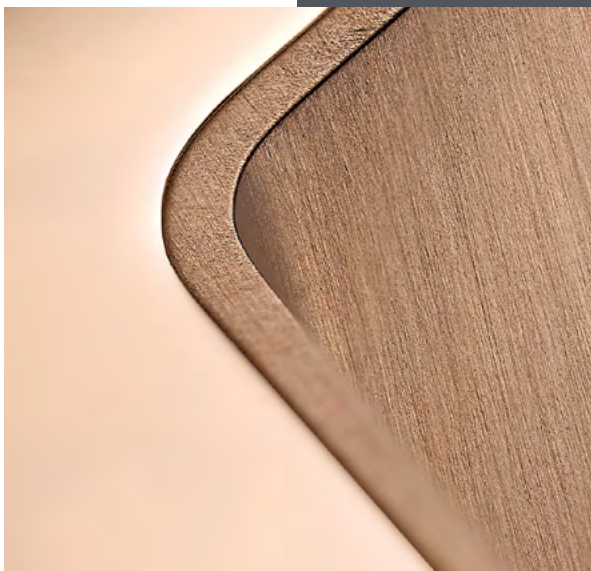

L'ART DES MATIÈRES

Conçue et développée avec le Studio F. A. Porsche, ICON-X promet d'être l'une des séries emblématiques de THG Paris.

Collection monolithique aux lignes intemporelles, élégante dans ses courbes et son profil élancé, ICON-X séduit jusque dans sa fabrication.

Sa production cumule en effet les audaces techniques : une électronique diversifiée pour répondre aux enjeux du sans-contact, une décoration par technologie laser, ou encore l'insertion de matériaux de nouvelle génération tels que le carbone ou le titane.

THE ART OF MATERIALS

Designed and developed with Studio F. A. Porsche, ICON-X promises to be one of THG Paris' emblematic series.

A monolithic collection with timeless lines, elegant in its curves and slender profile, ICON-X seduces even in its manufacture.

Indeed, its production combines technical audacity: advanced electronics dedicated to contactless challenges, decoration from laser technology, and the insertion of new-generation materials such as carbon or titanium.

TITANE | TITANIUM

Prisé par l'aéronautique et l'aérospatiale, le titane possède des propriétés de résistance thermique, mécanique et d'anti-corrosion exceptionnelles. Bio-compatible comme l'or et le platine, ce métal blanc léger se prête à merveille au design de pièces excessivement fines et aux décors minutieux.

Generally used in the aircraft and space industries, titanium has exceptional thermal, mechanical and anti-corrosion resistance properties. Bio-compatible like gold and platinum, this light white metal lends itself wonderfully to the design of excessively thin parts and meticulous decorations.



CARBONE OR | CARBON GOLD

Le "carbone gold" présente une allure spectaculaire changeant au gré de l'éclairage. Utilisé dans les bateaux du Vendée Globe ou dans les Formules 1, sa fabrication s'effectue dans des conditions de pression élevées afin de dévoiler la beauté intérieure du motif organique formé par les fibres de carbone. Cette « fusion » parfaite crée un effet nervuré dont la singularité et la finesse sont absolument uniques.

Carbon gold has a spectacular look that changes with the light. Used in boats in the Vendée Globe or in Formula 1 racing, it is manufactured under high pressure conditions to reveal the inner beauty of the organic pattern formed by the carbon fibres. This perfect "fusion" creates a ribbed effect whose singularity and finesse is absolutely unique.



MÉTAL | METAL

Le métal ne manque pas d'avantages pour la robinetterie de la gamme Icon-X. Ce mélange de métaux apporte ainsi un aspect épuré avec un design esthétique et une texture unique à cette robinetterie. La version en métal offre également la possibilité d'assortir des inserts colorés pour un rendu personnalisé sur-mesure.

Metal has many advantages in the Icon-X range of fittings. A mixture of metals gives the fittings a clean design with an aesthetic appearance and a unique texture. The metal version offers the possibility to match colored inserts for a customised and tailor-made finish.

TITANIUM



8

U7L.H64

PVD graphite | Graphite PVD

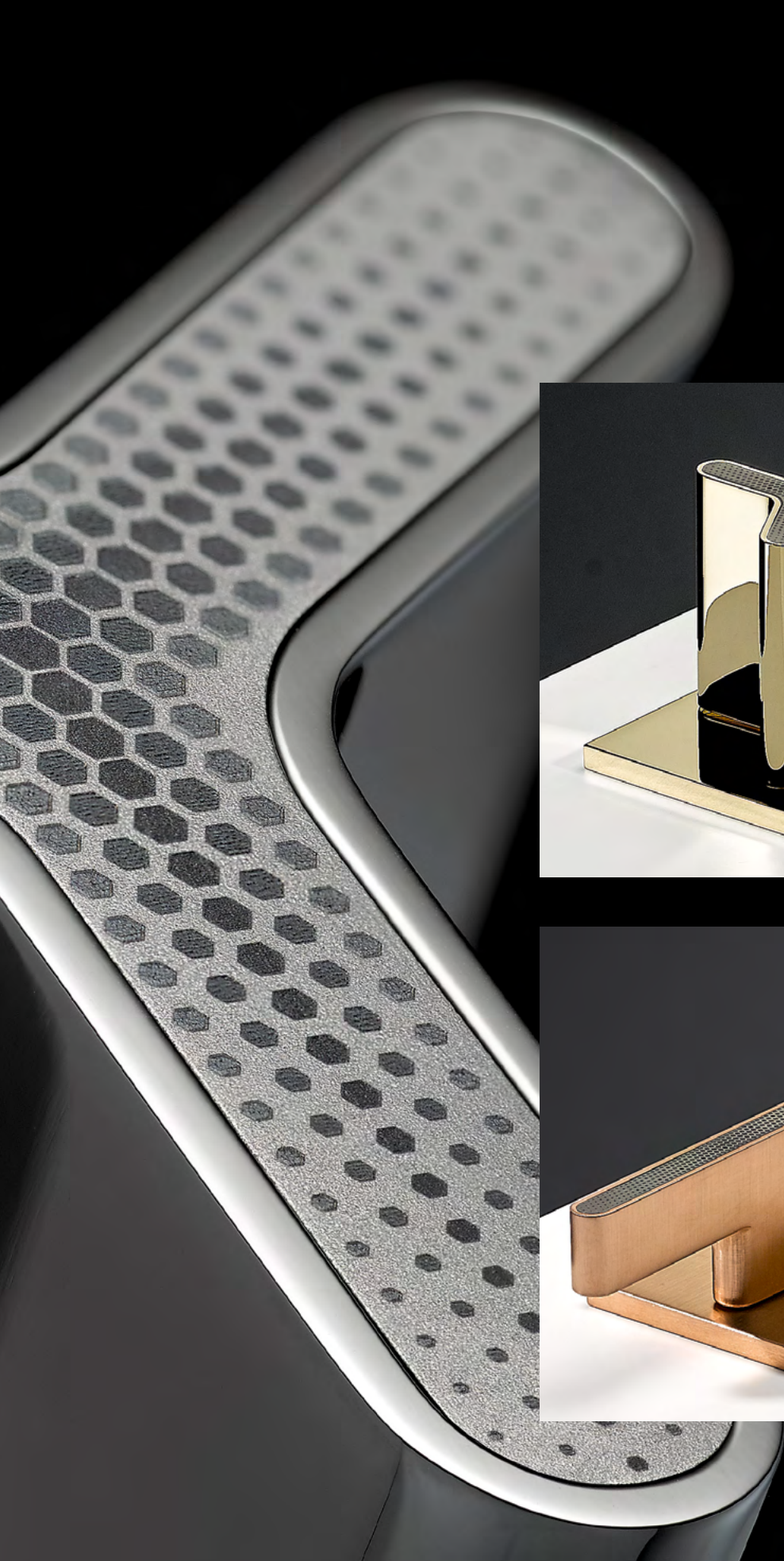

U7L.F30
Or pâle | Soft gold

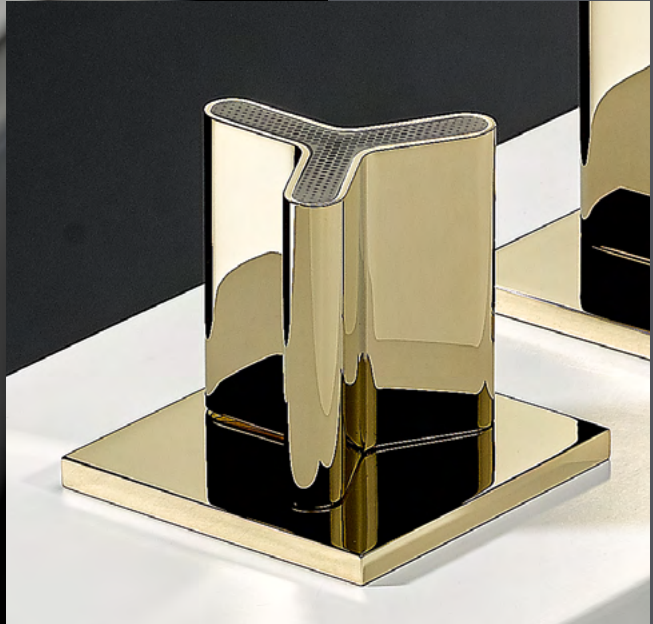

9



U7M.H60
PVD blush mat
Matt blush PVD



U7L.B01
Nickel | Polished nickel

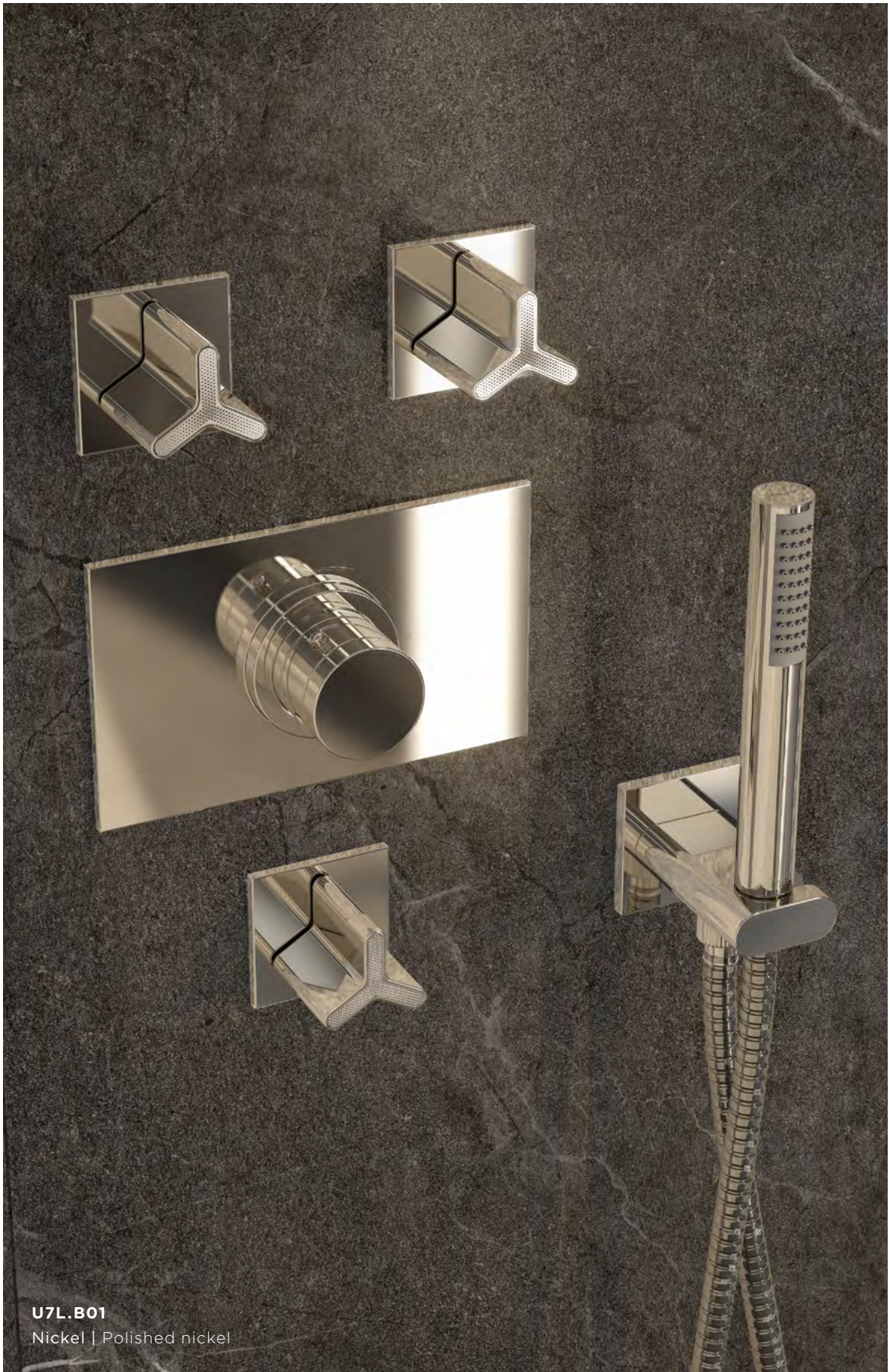

U7L.B01
Nickel | Polished nickel



U7L.B01

Nickel | Polished nickel

12





U7L.B01
Nickel | Polished nickel



U7S.A02
Chrome
Polished chrome



14



U7T.B01
Nickel | Polished nickel

CARBON GOLD

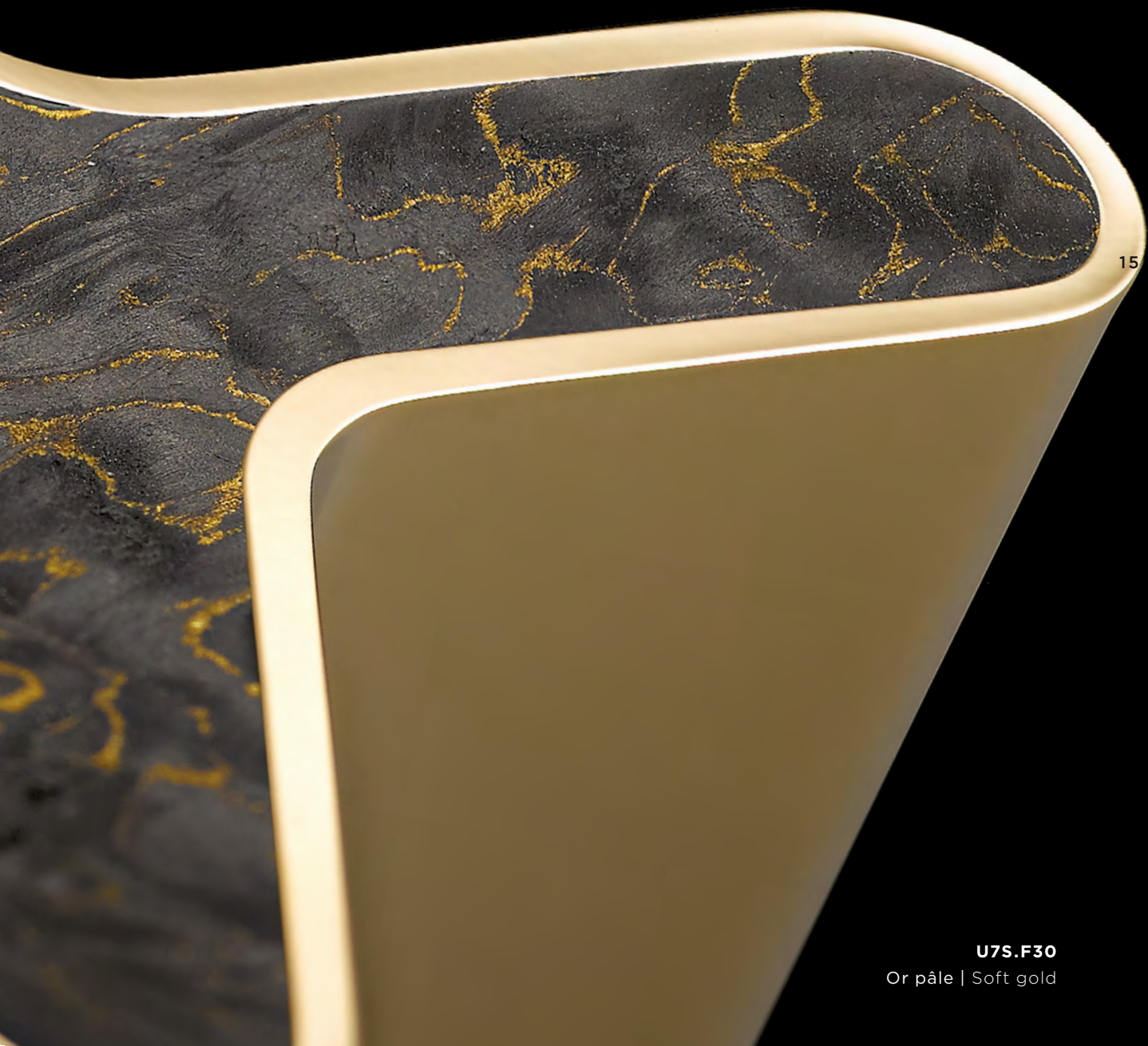

15

U7S.F30

Or pâle | Soft gold

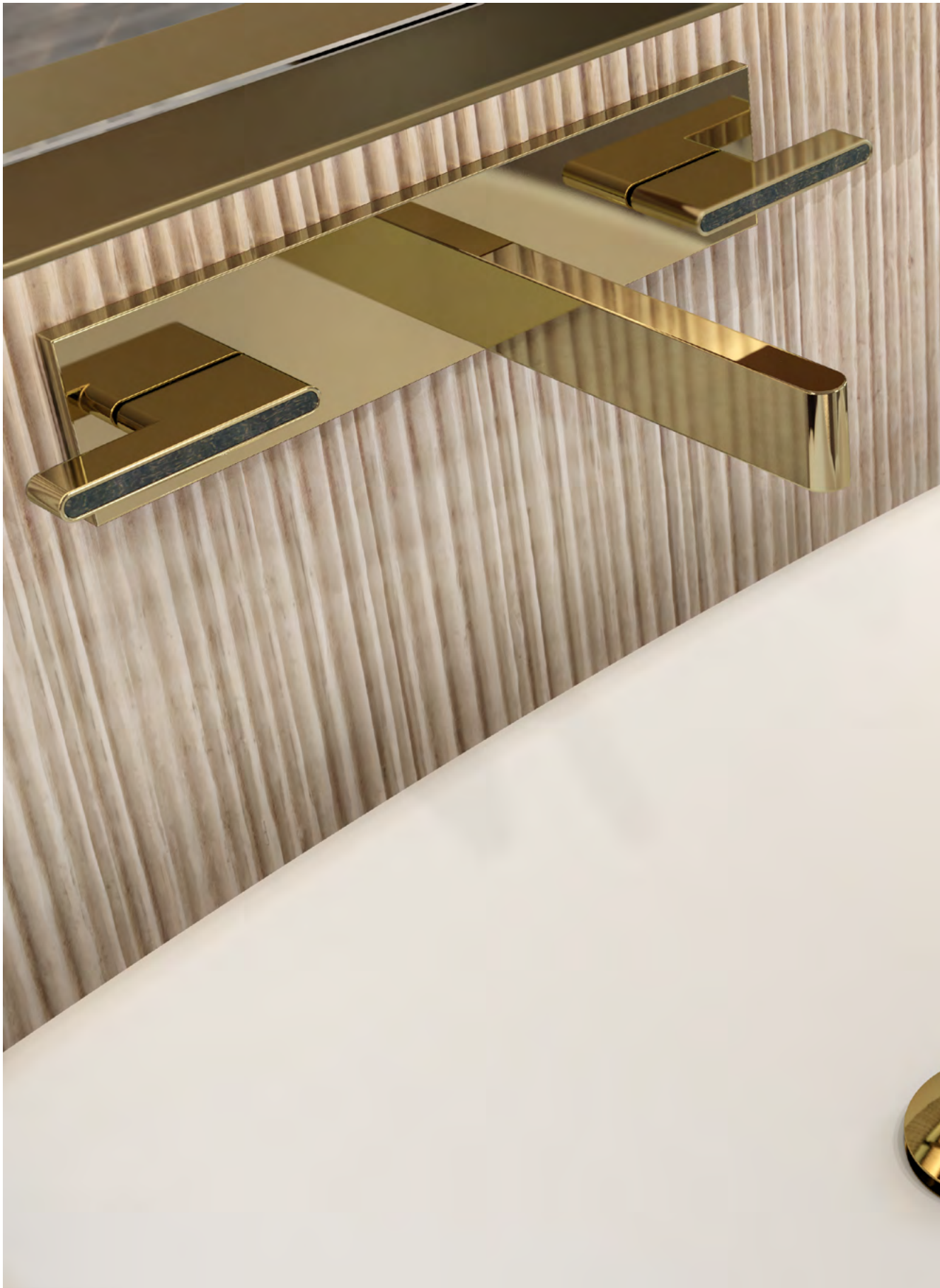





U7T.F30
Or pâle | Soft gold



U7J.HJ9

PVD laiton -
Insert PVD graphite mat
Brass color PVD -
Matt graphite PVD Inlay



20



U7K.HK3

PVD nickel -
Insert PVD blush mat
Nickel PVD -
Matt blush PVD inlay



INSERT MÉTAL | METAL INLAY



21

U7J.HJ2

PVD blush mat - insert PVD blush brillant
Matt blush PVD - Blush PVD inlay





U7K.HJ8

PVD nickel - Insert PVD graphite mat
Nickel PVD - Matt graphite PVD inlay





MÉTAL | METAL





U7G.A02

Chrome | Polished chrome



27



U7H.A02

Chrome | Polished chrome



U7G.A02
Chrome | Polished chrome



SYSTÈMES ÉLECTRONIQUES

CAPACITIF

Solution ultra-sensible, le capteur capacitif détecte la moindre variation du champ magnétique lié à la présence ou aux mouvements des personnes.

INFRAROUGE

Les capteurs infrarouges utilisent l'émission et la réception de faisceaux infrarouges afin de détecter la présence ou le mouvement de personnes dans leur zone de détection.

E THERMOSTATIQUE ÉLECTRONIQUE

Une simple pression sur le bouton pour déclencher le système et un réglage fin grâce à la molette permet de trouver rapidement la température idéale.



E

U7G.A02

Chrome | Polished chrome

ELECTRONIC SYSTEMS

CAPACITIVE

A highly sensitive solution, the capacitive sensor detects the slightest variation in the magnetic field due to the presence or movement of people.

INFRARED

Infrared sensors use the transmission and reception of infrared beams to detect the presence or movement of people in their detection zone.

E ELECTRONIC THERMOSTATIC

A simple push of the button activates the system and a fine adjustment while using the dial allows the ideal temperature to be found quickly.





30

U7G.A02
Chrome | Polished chrome



U7G.A02

Chrome | Polished chrome

31







U7G.A02

Chrome | Polished chrome



E

U7G.A02
Chrome | Polished chrome



U7G.H65
PVD graphite mat | Matt graphite PVD





36



U7G.A02

Chrome | Polished chrome

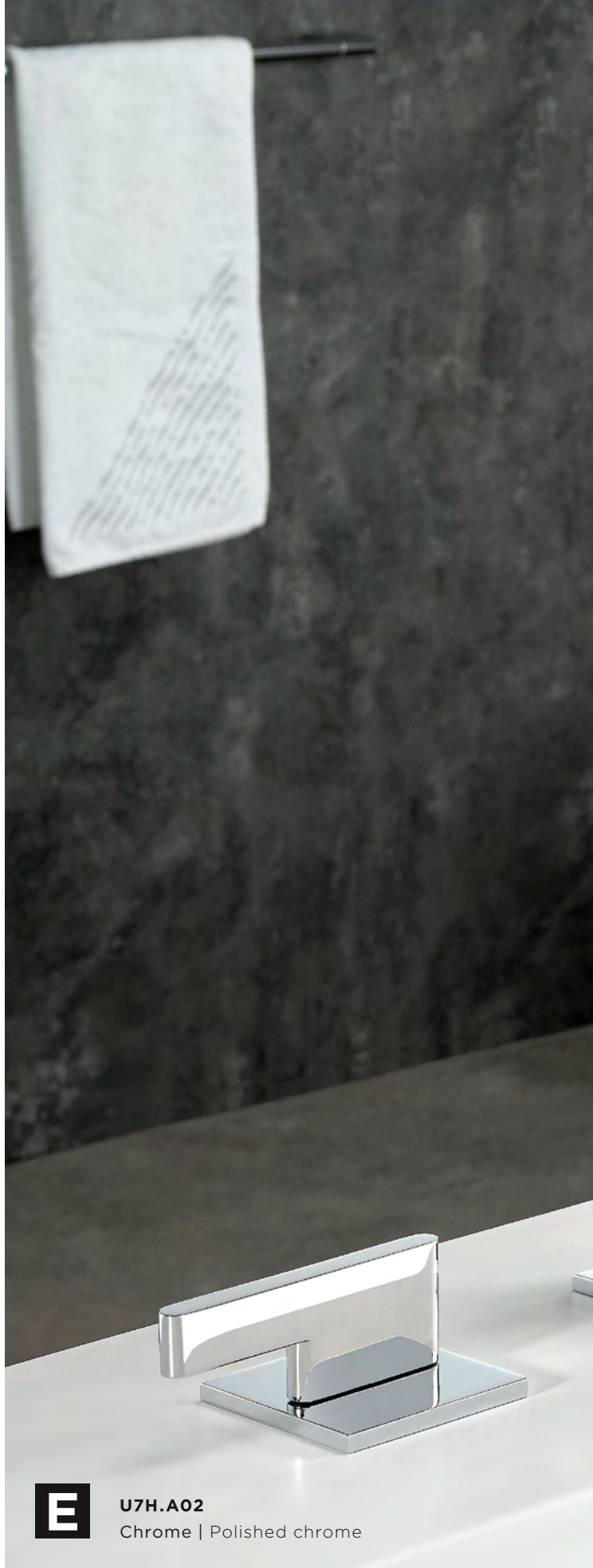

U7H.A02

Chrome | Polished chrome



SOLUTIONS, ENSEMBLES ET PRODUITS ASSOCIÉS
SOLUTIONS, PACKAGES AND ASSOCIATED PRODUCTS

ENSEMBLE DES COLLECTIONS COLLECTION DETAILS

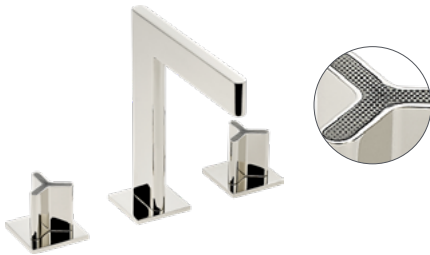

U7L ICON-X TITANE / TITANIUM



U7M ICON-X TITANE / TITANIUM
à manettes / with lever handles



U7S ICON-X CARBONE OR / CARBON GOLD



U7T ICON-X CARBONE OR / CARBON GOLD
à manettes / with lever handles

38

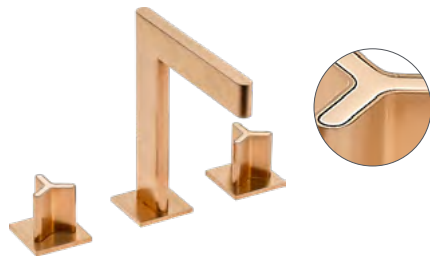

U7J ICON-X INSERT MÉTAL / METAL INLAY



U7K ICON-X INSERT MÉTAL / METAL INLAY
à manettes / with lever handles



U7G ICON-X MÉTAL / METAL

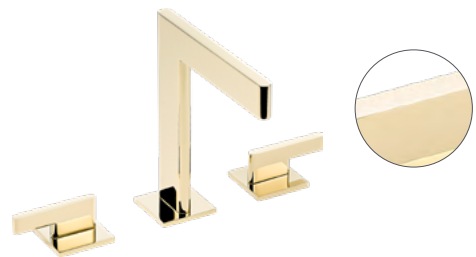

U7H ICON-X MÉTAL / METAL
à manettes / with lever handles

SOLUTIONS, ENSEMBLES ET PRODUITS ASSOCIÉS

SOLUTIONS, PACKAGES AND ASSOCIATED PRODUCTS



Capacitif - Capacitive



Infrarouge - Infrared



Électronique - Electronic

LAVABO BASINS



151 - 309/S

Ensemble mélangeur de lavabo avec vidage

Rim mounted basin mixer and pop-up waste



6500 - 309/S

Ensemble mitigeur de lavabo avec vidage

Rim mounted single lever basin mixer and pop-up waste



40GB - 40AC - 316 - 309/S

Ensemble mélangeur de lavabo mural avec vidage

Wall mounted basin mixer and pop-up waste

39



40GBP22 - 40ACP22 - 316 - 309/S

Ensemble mélangeur de lavabo mural sur plaque, avec vidage

Wall mounted basin mixer on plate and pop-up waste



6543PB - 6543A - 316 - 309/S

Ensemble mitigeur de lavabo mural sur plaque, avec vidage

Wall mounted basin mixer on plate and pop-up waste



6541B - 5840/MA - 316 - 309/S

Ensemble mitigeur de lavabo mural, avec vidage

Wall mounted basin mixer and pop-up waste

SOLUTIONS, ENSEMBLES ET PRODUITS ASSOCIÉS
SOLUTIONS, PACKAGES AND ASSOCIATED PRODUCTS

LAVABO BASINS



170E - 309/S

Bec de lavabo à détection électronique capacitive avec vidage

Basin spout with capacitive electronic detection and pop-up waste



22GAB - 6770B - 6770A - 316 - 309/S

Ensemble mitigeur de lavabo mural, à commande électronique avec vidage

Wall mounted basin mixer with electronic control and pop-up waste



170V - 309/S

Ensemble mitigeur de lavabo à commande électronique avec vidage

Rim mounted basin mixer with electronic control and pop-up waste

40



22GAB - 6702C - 316 - 309/S

Ensemble mitigeur de lavabo mural à déclenchement infrarouge avec vidage

Wall mounted basin mixer with Infrared trigger cell electronic system and pop-up waste



SOLUTIONS, ENSEMBLES ET PRODUITS ASSOCIÉS
SOLUTIONS, PACKAGES AND ASSOCIATED PRODUCTS

BAIN BATH



1132SG
 Ensemble mélangeur de bain avec douchette eau mitigée
 Rim mounted bath mixer - handshower



41SGBP22 - 40ACP22 - 6561B - 5840/MA
 Ensemble mélangeur de bain mural sur plaque - douchette eau mitigée
 Wall mounted bath mixer on plate - handshower



5401BEH - 5401AHC - 54 - 42SGB
 Ensemble bain mural thermostatique
 Thermostatic wall mounted bath mixer



6770DB - 6770DA - 54 - 42SGB
 Ensemble mitigeur de bain mural, à commande électronique avec vidage
 Wall mounted bath mixer with electronic control and pop-up waste

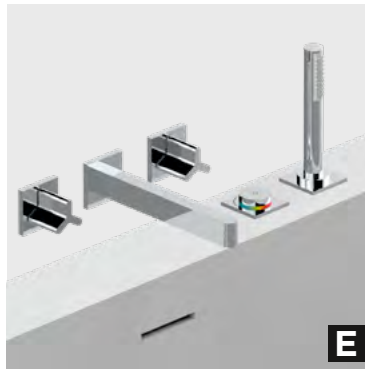

41SGB - 40AC - 6760/60A
 Ensemble mélangeur de bain mural avec douchette eau mitigée sur gorge
 Wall mounted bath mixer and rim mounted handshower

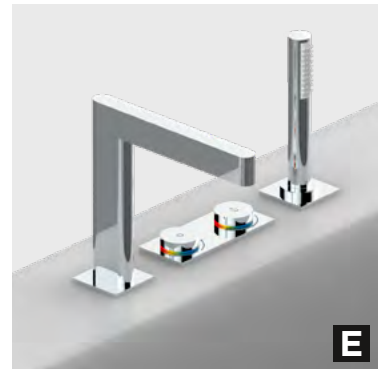

6760D - 29SG - 60A
 Ensemble mitigeur de bain à commande électronique avec vidage
 Rim mounted bath mixer with electronic control and pop-up waste

SOLUTIONS, ENSEMBLES ET PRODUITS ASSOCIÉS

SOLUTIONS, PACKAGES AND ASSOCIATED PRODUCTS

DOUCHE SHOWER



5401BEH - 5400AHC - 54 - 84C - 281C

Ensemble douche thermostatique 2 fonctions simultanées pomme & douchette
Thermostatic shower set with 2 simultaneous functions: shower head & handshower



6772DB - 6770DA - 54 - 490

Ensemble douche à commande électronique 2 fonctions : pomme & douchette
Thermostatic shower set with electronic control, 2 functions: shower head & handshower

42



5100B - 5200AE - 3x 30B - 3x 30/HA - 58 - 6x290/B - 489

Ensemble douche thermostatique 3 fonctions simultanées : Ciel de pluie, jets & douchette
Thermostatic shower set with 3 simultaneous functions: Skyshower, body jet & handshower



5541BEH - 5541AHC - 54 - 82 - 288L - 42SGB

Ensemble douche thermostatique 3 fonctions : pomme + douchette + bec
Thermostatic shower set with 3 functions: shower head & handshower + spout

SOLUTIONS, ENSEMBLES ET PRODUITS ASSOCIÉS

SOLUTIONS, PACKAGES AND ASSOCIATED PRODUCTS

DOUCHE SHOWER

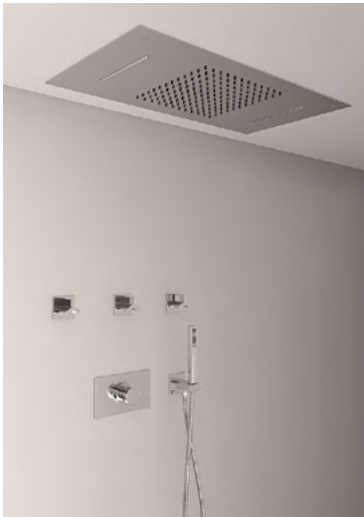

5100B - 5200AE - 3x30B - 3x 30/HA - 54 - 492

Ensemble douche thermostatique 3 fonctions simultanées : ciel de pluie + lame d'eau + chromothérapie & douchette

Thermostatic shower set with 3 simultaneous functions: skyshower + water blade + chromotherapy & handshower



5500BE - 5500AE - 58 - 82V - 281EP

Ensemble douche thermostatique 2 fonctions : pomme & douchette

Thermostatic shower set with 2 functions: shower head & handshower



5400BE - 5400AE - 54 - 84L - 280C

Ensemble douche thermostatique 2 fonctions simultanées pomme & douchette

Thermostatic shower set with 2 simultaneous functions: shower head & handshower

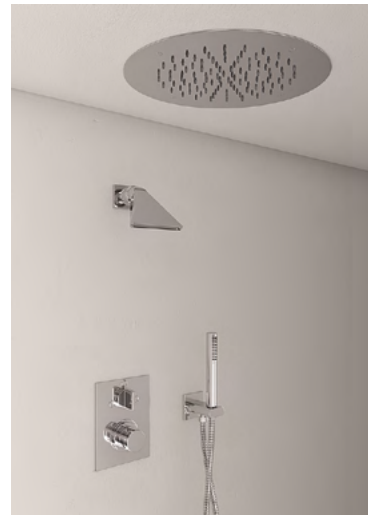

5600BE - 5600AE - 54 - 3640 - 494

Ensemble douche thermostatique 3 fonctions : ciel de pluie + douche sportive & douchette

Thermostatic shower set with 3 functions: skyshower + sports shower & handshower

SOLUTIONS, ENSEMBLES ET PRODUITS ASSOCIÉS

SOLUTIONS, PACKAGES AND ASSOCIATED PRODUCTS

BIDET WC BIDET WC



**5840/MBG -
5840/MA**

Ensemble hygiénique
alimenté par mitigeur
WC douche set with
single lever mixer



**5840/9 - 30B -
30/HA**

Ensemble hygiénique
WC douche set



**219TC
TECE**

Plaque de
déclenchement WC
WC flush plate



**219SC
GEBERIT**

Plaque de
déclenchement WC
WC flush plate

ACCESSOIRES ACCESSORIES

44



504N

Anneau
porte-serviette
Towel ring



514/60

Porte-serviette -
longueur 60 cm
Single towel rail -
length 60 cm



514/45

Porte-serviette -
longueur 45cm
Single towel rail -
length 45 cm

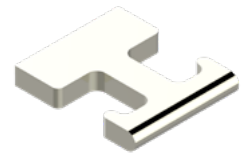

517

Porte-peignoir
Robe hook



613

Distributeur de savon
Soap dispenser

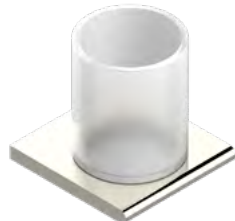

536

Porte-verre
Tumbler



500

Porte-savon
Soap dish

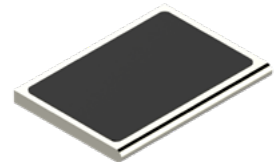

564S

Tablette métal avec tapis antidérapant
Metal shelf with anti-slip pad

SOLUTIONS, ENSEMBLES ET PRODUITS ASSOCIÉS

SOLUTIONS, PACKAGES AND ASSOCIATED PRODUCTS

ACCESSOIRES ACCESSORIES



542
Porte-papier
WC paper holder

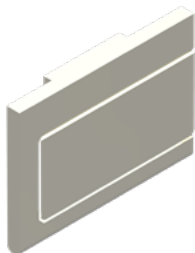

538AC
Porte-papier
WC paper holder



4700C
Ensemble porte-balai
WC
WC-brush holder



4720C
Ensemble porte-balai
WC mural
Wall mounted WC-
brush holder



666
Miroir à poser
Freestanding mirror



667
Miroir mural
Wall mounted mirror



669C
Miroir mural sur bras
double, éclairage LED
Wall mounted mirror,
double arm, LED illuminated



SOLUTIONS, ENSEMBLES ET PRODUITS ASSOCIÉS

SOLUTIONS, PACKAGES AND ASSOCIATED PRODUCTS

ACCESSOIRES ACCESSORIES



711CL
Corbeille à couvercle
basculant
Waste bin
with tilting lid



710CL
Corbeille à pédale
Waste bin with lid
and pedal



10C
Porte-serviettes
Towel stand



G00.623
Pont de baignoire
Bath rack

BOUTONS HARDWARE

46

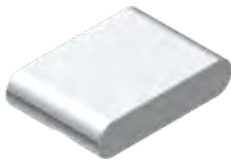

26BT
Bouton petit modèle
Small size knob

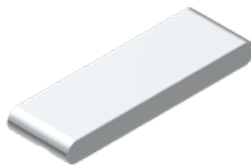

26BP
Bouton moyen modèle
Medium door knob

SÈCHE-SERVIETTES TOWEL WARMERS



TWR3E
Sèche-serviettes 3
barres, électrique
Towel warmer 3 rails,
electric



TWR4E
Sèche-serviettes 4
barres, électrique
Towel warmer 4 rails,
electric



TWR6E
Sèche-serviettes 6
barres, électrique
Towel warmer 6 rails,
electric



TWR9E
Sèche-serviettes 9
barres, électrique
Towel warmer 9 rails,
electric

SOLUTIONS, ENSEMBLES ET PRODUITS ASSOCIÉS
SOLUTIONS, PACKAGES AND ASSOCIATED PRODUCTS

SANITAIRE ET VASQUES SANITARY AND BASINS



V500 FILLMORE
 Vasque à poser
 On counter basin



V540 CARLA
 Vasque à encastrer
 Under counter basin



V590 MONCEAU
 Vasque à poser
 On counter basin



V512 MOONSHINE
 Vasque à poser
 On counter basin



V521 SHADE
 Vasque à poser
 On counter basin

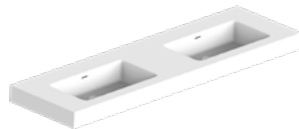

PV521 BIRDY
 Plan double vasque
 à poser
 Double inset
 countertop

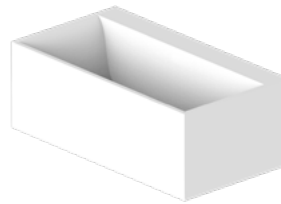

B542 EGO
 Baignoire à poser
 avec plage
 Bathtub freestanding
 with rim

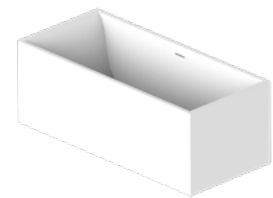

B543 EGO
 Baignoire à poser
 Freestanding bathtub



B591 MONCEAU
 Baignoire à poser
 avec plage
 Bathtub freestanding
 with rim

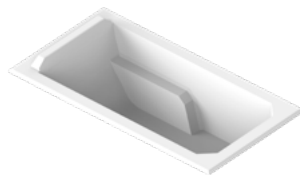

B511 MELRIDGE
 Baignoire à encastrer
 Built-in bathtub



Retrouvez nos sanitaires, leurs accessoires et toutes les possibilités de personnalisation dans notre Cahier Technique Collections Bain.

Find our sanitaryware, their accessories and all customisation possibilities in our

Sanitaryware Technical Specifications book.

Téléchargez tous nos catalogues sur notre site internet | Download all our catalogues on our website
WWW.THG-PARIS.COM



FINITIONS FINISHES

Plus de finitions disponibles sur THG-PARIS.COM

For more finishes and additional information, please visit THG-PARIS.COM



A02
Chrome
Polished
chrome



B01
Nickel
Polished nickel



C01
Nickel mat
Matt nickel



H03
Vieil argent
verniss brillant
Lacquered
antique silver



H62
PVD couleur
blush
Blush color
PVD



H60
PVD couleur
blush mat
Matt blush
color PVD



F30
Or pâle
Soft gold



F31
Or pâle mat
Soft matt gold



F01
Doré
Polished gold



F07
Doré mat
Matt gold



D01
Bronze clair
verniss brillant
Lacquered
light bronze

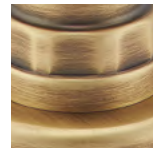

D05
Bronze clair
verniss mat
Lacquered
matt bronze

48



H64
PVD couleur
graphite
Graphite color
PVD



H65
PVD couleur
graphite mat
Matt graphite
color PVD



H55
PVD couleur
nickel
Nickel color
PVD



H56
PVD couleur
nickel mat
Matt nickel
color PVD



H66
PVD couleur
umber
Umber color
PVD



H67
PVD couleur
umber mat
Matt umber
color PVD



H52
PVD couleur
doré
Gold color
PVD



H53
PVD couleur
doré mat
Matt gold
color PVD



H49
PVD couleur
laiton
Brass color
PVD



H50
PVD couleur
laiton mat
Matt brass
color PVD

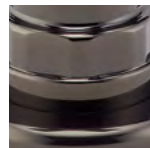

F33
PVD couleur
bronze brown
Brown bronze
color PVD



F34
PVD couleur
bronze brown mat
Matt brown
bronze color PVD

CONTACT

SIÈGE SOCIAL | HEAD OFFICE

THG FRANCE

35, rue Tournière - BP 80212
Béthencourt-sur-Mer
80535 Friville cedex - France
+33 (0)3 22 60 20 80
contact@thg.fr
www.thg-paris.com

FILIALES | SUBSIDIARIES

THG USA LLC

Head office
441 NW - 1st avenue
Fort Lauderdale
FL 33301 - USA
Tel. +1 954 425 8225
info@thgusa.com

THG UK

11 Commercial Way,
London NW10 7XF
United Kingdom
Tel. +44 (0)20 8202 8288
salesuk@thg-paris.com

THG RUSSIA

Leningradskiy avenue,
bld. 37A, housing 14
125167 Moscow - Russia
Tel. +7 495 800 8225
thg@thg-russia.ru

THG DEUTSCHLAND GMBH

Gutleutstr. 96
60329 Frankfurt/Main
Deutschland
Tel. +49 (0)69/ 25 78 14 33
info@thg-deutschland.de

THG ASIA

Room 1901, Rui Jin Building
205 South Maoming Road
Shanghai - PRC
上海市卢湾区茂名南路205号瑞金大厦1901室
电话/ Tel. +86 (21) 613 527 38
contact@thg-asia.cn

THG MIDDLE EAST

Alan Haddad
Dubai Design District
Building 3, Office 605
Dubai, UAE
Tel. +971 508 456 003
contact@thg-paris.com

SHOWROOMS THG | THG SHOWROOMS

PARIS

152 bd Haussmann
75008 Paris - France
Tel. +33 (0)1 44 20 09 20
contact@thg-bathconcept.com
www.thg-bathconcept.com

NEW YORK

D&D Building
Showroom 1206 - 12th floor
979 Third Avenue - New-York
NY 10022 - USA
Tel. +1 (917) 242 8911
info@thgusa.com

LONDON

4 Pont Street
London SW1X 9EL
United Kingdom
Tel. +44 (0)20 7838 7788
salesuk@thg-paris.com
london.thg-paris.com

FRANKFURT

Gutleutstr. 96
60329 Frankfurt/Main
Deutschland
Tel. +49 (0)69/ 25 78 14 33
info@thg-deutschland.de

CRÉDITS | CREDITS

CONCEPTION ET RÉALISATION

THG Paris

IMPRESSION

Imprimerie Jean Bernard

Textes et photos non contractuels et susceptibles d'être modifiés sans préavis | Text and pictures are not binding and can be modified without any previous notice

© THG Paris Mars 2021



Entreprise
du Patrimoine
Vivant
L'excellence
des savoir-faire
français



FABRICANT FRANÇAIS

THG[®]
P A R I S
THG-PARIS.COM