

Saint-Germain

Club Saint-Germain

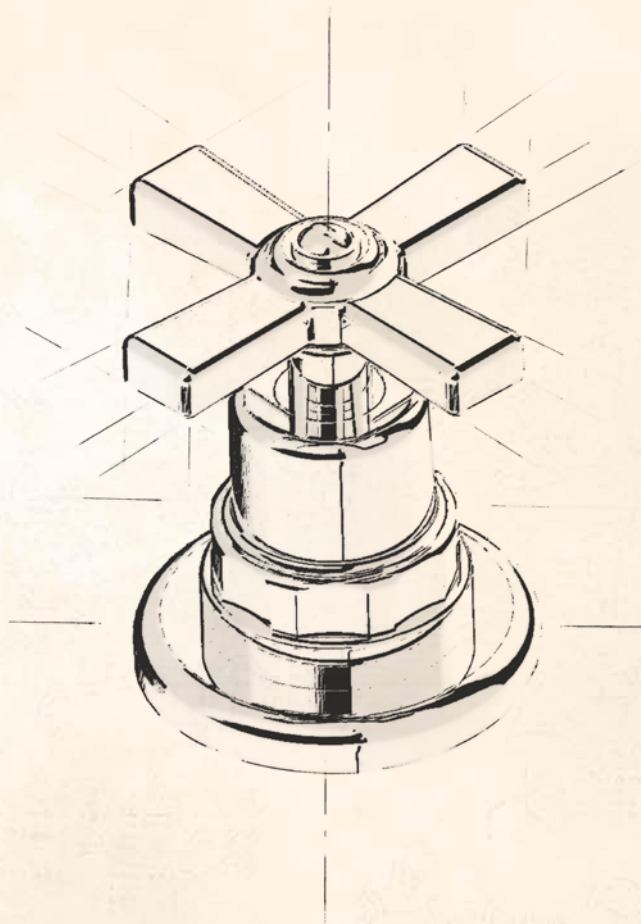

THG[®]
P A R I S

THG[®]
P A R I S



1971

2022

2

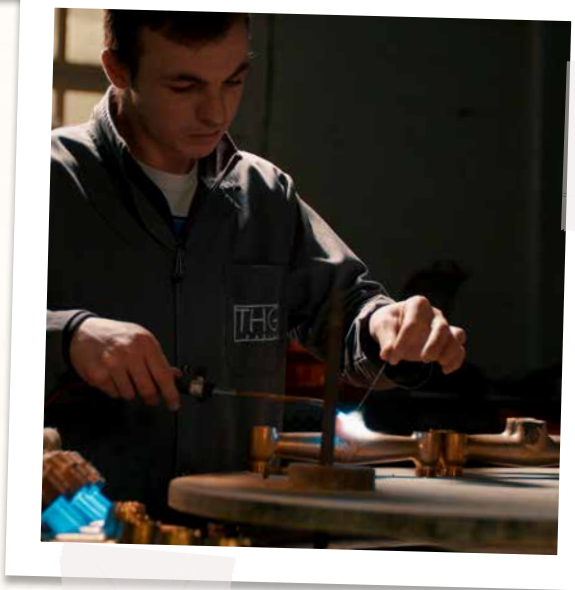
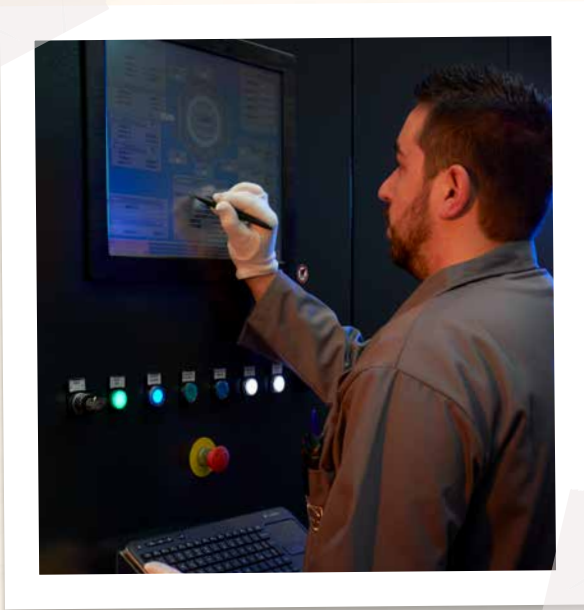

THG Paris :
Un savoir-faire français d'excellence en robinetterie de luxe

1956, Béthencourt-sur-Mer (France) :
trois hommes - André Tétard,
Julien Haudiquez et Alexandre
Grisoni - créent THG avec une
vision pionnière : le robinet,
le luxe et la décoration ne font
qu'un. En France, où le luxe
a toujours eu une place à part,
le succès est immédiat. Très vite,
il devient mondial.

En tant que fabricant français
de robinetteries et d'accessoires
de bain, la Maison THG Paris
évoque à la fois l'artisanat
et l'industrie à son
plus haut niveau.

Dotée d'un savoir-faire unique,
elle propose des produits
d'exception aux formes
et aux textures incomparables.

En 2012, l'expertise "Made in
France" de THG Paris est reconnue
avec l'obtention du prestigieux
label Entreprise du Patrimoine
Vivant (EPV). Sa force réside dans
sa créativité en collaborant
avec de célèbres Maisons et
des designers de renom.

Représentée dans plus de 60 pays,
la Maison s'est construite une
forte réputation à l'international
en tant que pionnier et
précurseur sur le marché de
la robinetterie haut de gamme.
Ces dernières années, THG Paris
a su imposer sa présence par
l'ouverture de showrooms dans
les plus grandes villes du
monde telles que Londres, Paris,
New York, Shanghai ou Dubai.

3

THG Paris:
French know-how of excellence in luxury fitting

1956, Béthencourt-sur-Mer (France):
three men - André Tétard,
Julien Haudiquez and Alexandre
Grisoni - create THG with a
pioneering vision: taps,
luxury and decoration become one.
In France, where luxury has
always had a special place,
success was immediate. Very
quickly, it became worldwide.

As a French manufacturer
of bathroom fittings and
accessories, THG Paris evokes
both craftsmanship and
industry at its highest level.

With its unique know-how, it
offers exceptional products with
incomparable shapes and textures.

In 2012, THG Paris' "Made in
France" expertise is recognised
with the awarding of the
prestigious Entreprise du
Patrimoine Vivant (EPV) label.
Its strength lies in its creativity,
working with famous design
houses and well-known designers.

Represented in more than 60
countries, the company has
built up a strong international
reputation as a pioneer and
precursor in the high-end
bathroom fittings market
In recent years, THG Paris
has established its presence
by opening showrooms in
the world's largest cities
such as London, Paris, New
York, Shanghai and Dubai.

Saint-Germain, collection éponyme du très chic quartier parisien

Paris, capitale du pays d'origine de la Maison THG, fait partie de l'ADN de notre marque qui porte son nom et symbolise à elle seule l'art de vivre à la française.

La Ville Lumière est une source inépuisable d'inspiration.

La collection Saint-Germain s'inscrit dans cette histoire en empruntant son nom à un célèbre quartier de la capitale : Saint-Germain-des-Près.

Connu pour ses galeries d'art, ses boutiques de haute couture, ses cafés emblématiques dont le Flore autrefois fréquenté par les personnalités du Paris littéraire et artistique

du 20^e siècle, ce quartier chic se vit comme dans un village en plein centre de Paris.

Prendre le temps de flâner sur les quais de Seine, au jardin du Luxembourg avec sa fontaine Médicis ou encore sur le Pont des Arts est une invitation à l'imaginaire et au plaisir des sens où l'eau n'est jamais très loin pour amplifier ce bien-être. Tel est le lien profond entre Paris et votre salle de bain souligné par la collection Saint-Germain aussi bien dans son style, sa forme, et ses matériaux et finitions rigoureusement sélectionnés.

Saint-Germain, eponymous collection of the very chic parisian district

Paris, the capital of THG's home country, is part of the DNA of our brand, which bears its name and symbolises the French art of living. The City of Light is an inexhaustible source of inspiration. The Saint-Germain collection is part of this history by borrowing its name from a famous district of the capital: Saint-Germain-des-Près.

Known for its art galleries, haute couture boutiques, emblematic cafés, including the Flore, once frequented by the literary and artistic personalities of Paris of the 20th century, this chic

district is like living in a small village in the centre of Paris.

Taking the time to stroll along the banks of the Seine, in the Luxembourg Garden with its Medicis fountain or on the Pont des Arts is an invitation to the imagination and to the pleasure of the senses, where water is never far away to amplify this well-being.

This is the deep link between Paris and your bathroom, highlighted by the Saint-Germain collection in its style, shape, and its rigorously selected materials and finishes.



Saint-Germain



*Saint-Germain
à manettes / with lever handles*



Club Saint-Germain



*Club Saint-Germain
à manettes / with lever handles*

Quand le style parisien s'invite dans votre salle de bain...

Il suffit d'une balade à travers les rues parisiennes pour côtoyer petite et grande Histoire. Partout où les yeux se posent, l'imagerie métallique se réplique à l'infini.

La collection Saint-Germain capture le style industriel des monuments parisiens aux structures métalliques : le Pont des Arts et celui de Bir-Hakeim, le Grand Palais et, le plus célèbre de ces monuments, la Tour Eiffel qui symbolise à son plus haut degré le savoir-faire technique français. Avec ses courbes élancées et ses robustes poutres, la Dame de fer a fait l'objet d'une conception audacieuse à l'image de cette collection dont les robinets,

aux lignes simples et rigoureuses, sont de véritables objets d'art fonctionnels et contemporains.

Elle insuffle une période rétro avec des notes soigneusement dosées et contrebalancées par une aspiration à la simplicité avec, toutefois, un travail méticuleux de la base du bec et des poignées. Agrémentées d'écrous et de vis, la collection rappelle un style industriel réimaginé pour une nouvelle ère.

Ces détails extraordinaires sont le résultat d'un travail artisanal talentueux.

7

When Parisian style comes into your bathroom...

A stroll through the streets of Paris is enough to bring you into contact with history, both great and small. Everywhere you look, the metallic image is endlessly replicated.

The Saint-Germain collection captures the industrial style of Parisian monuments with metal structures: the Pont des Arts and the Bir-Hakeim Bridge, the Grand Palais and, the most famous of these monuments, the Eiffel Tower which symbolises to its highest degree the French technical know-how. With its slender curve and sturdy beams, the Iron Lady has been boldly designed in the same

way as this collection whose taps with their simple and rigorous lines, are real functional and contemporary objects of art.

It infuses a retro period with carefully measured notes balanced by an aspiration to simplicity with, however, a meticulous work on the base of the spout and the handles. Embellished with nuts and screws, they recall an industrial style reimagined for a new era.

These extraordinary details are the result of talented craftsmanship.





Saint-Germain





//

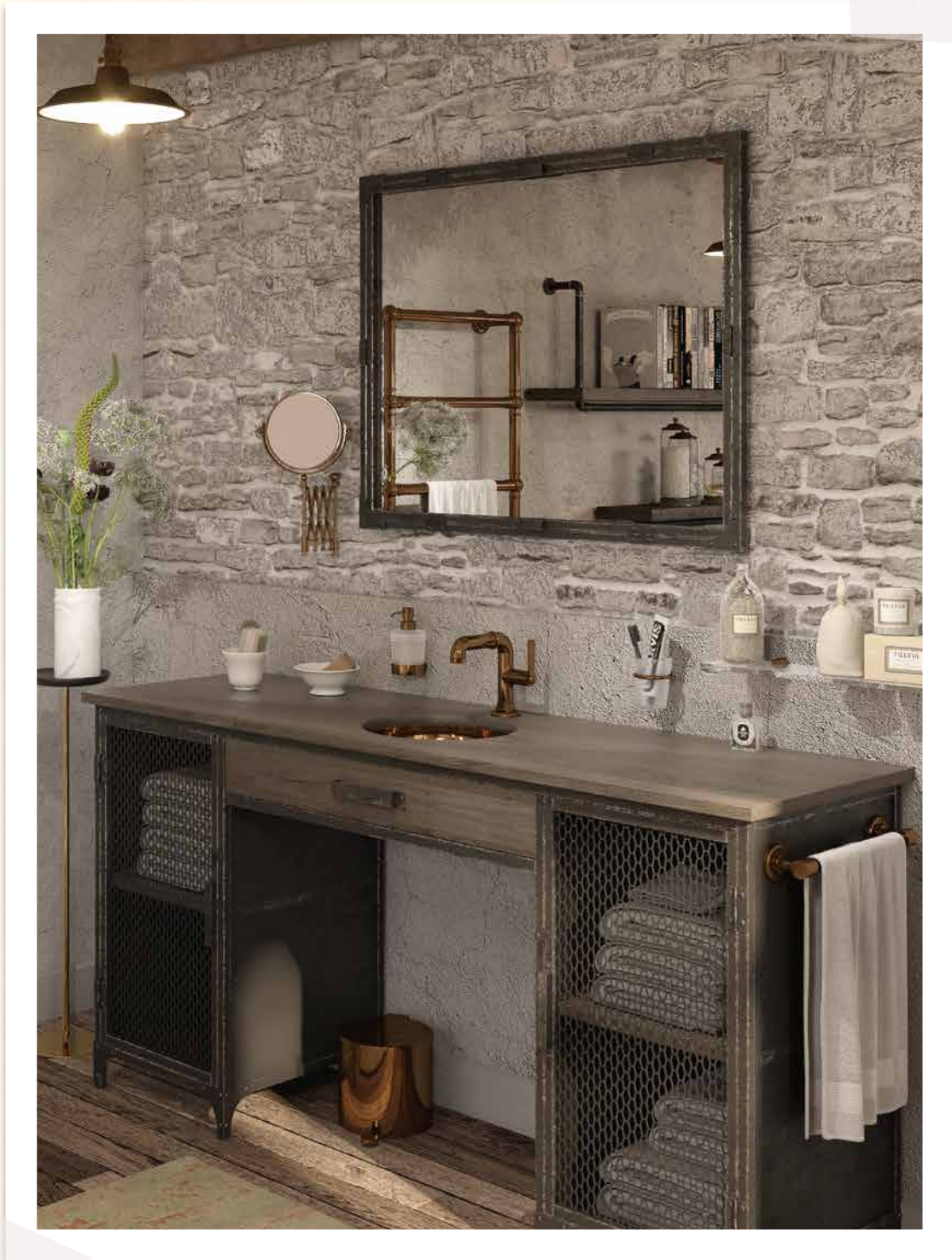

G7C.6500-536-613-564-668-710CL-520/30

Ensemble mitigeur de lavabo avec vidage et accessoires coordonnés
Single lever basin mixer set with waste and matching accessories

UNE AMBIANCE CRÉATIVE AUX MATIÈRES
BRUTES, SYMBOLE DU PARIS LITTÉRAIRE

« Tel était le Paris de notre jeunesse,
au temps où nous étions très pauvres
et très heureux. » (Ernest Hemingway)

Attirant dès le Siècle des Lumières les
écrivains et les peintres - Racine, Balzac,
George Sand, Manet, Delacroix - Saint-
Germain-des-Prés est l'épicentre des arts et
de la philosophie à l'aube des années 1850.

Cette décoration nous replonge dans ce
foyer de la bohème artistique avec des
notes à la fois masculines et intimistes
du lieu, apportées par des matières brutes
telles que le cuivre, le bois et le cuir.

La robinetterie en PVD blush coordonnée
avec la vasque et la baignoire cuivrées
donne une finition brute à l'ensemble au
caractère bien trempé. Le robinet sur pied
impose son style de très haute qualité avec
l'audace de la réutilisation d'une malle comme
lavabo. La salle de bain devient un atelier
d'artistes où l'art d'agencer les matières et
les accessoires est un tableau à lui seul.

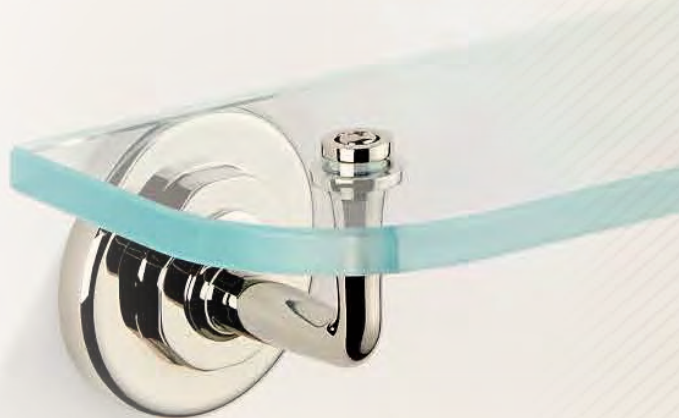

A CREATIVE ATMOSPHERE WITH RAW
MATERIALS, A SYMBOL OF PARIS LITTÉRAIRE

"Such was the Paris of our youth,
when we were very poor and very happy."
(Ernest Hemingway)

13

Attracting writers and painters from
the Age of Enlightenment - Racine, Balzac,
George Sand, Manet, Delacroix - Saint-
Germain-des-Prés is the epicentre of the arts
and philosophy at the dawn of the 1850s.

This decoration plunges us back into this home
of artistic bohemian with both masculine and
intimate notes of the place brought by raw
materials such as copper, wood and leather.

The blush PVD fittings coordinated with the
copper basin and bathtub give a raw finish to
the whole with a well tempered character. The
pedestal tap imposes its high quality style
with the audacity of reusing a trunk as a
washbasin. The bathroom becomes an artist's
studio where the art of combining materials
and accessories is a painting in itself.



Saint-Germain



14



G00.613P
Distributeur de savon
Soap dispenser



G7C.6500S
Mitigeur de lavabo sur colonne
Free-standing basin mixer

Saint-Germain



G7C.6508S-520/60-620

Ensemble mitigeur bain/douche sur colonne avec porte-serviettes et porte-savon
Free-standing bath/shower mixer set with single towel rail and soap dish





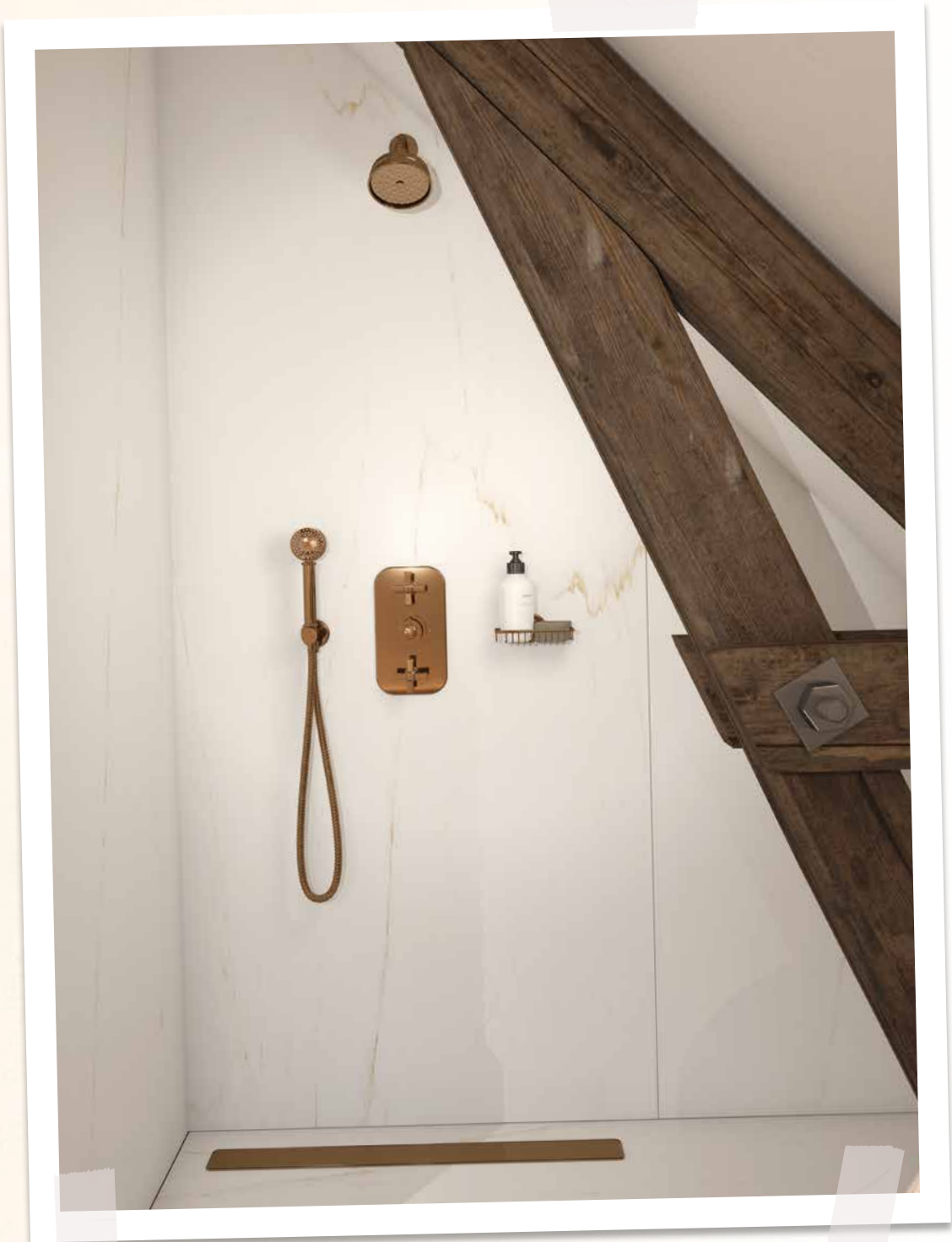

G7C.5400BE-5400AE-54-82-187-620

Ensemble de douche thermostatique avec pomme, douchette et porte-savon
Thermostatic shower set with shower head, handshower and soap dish



G7C.TWT4H2

Sèche-serviettes Traditionnel
Traditional towel warmer

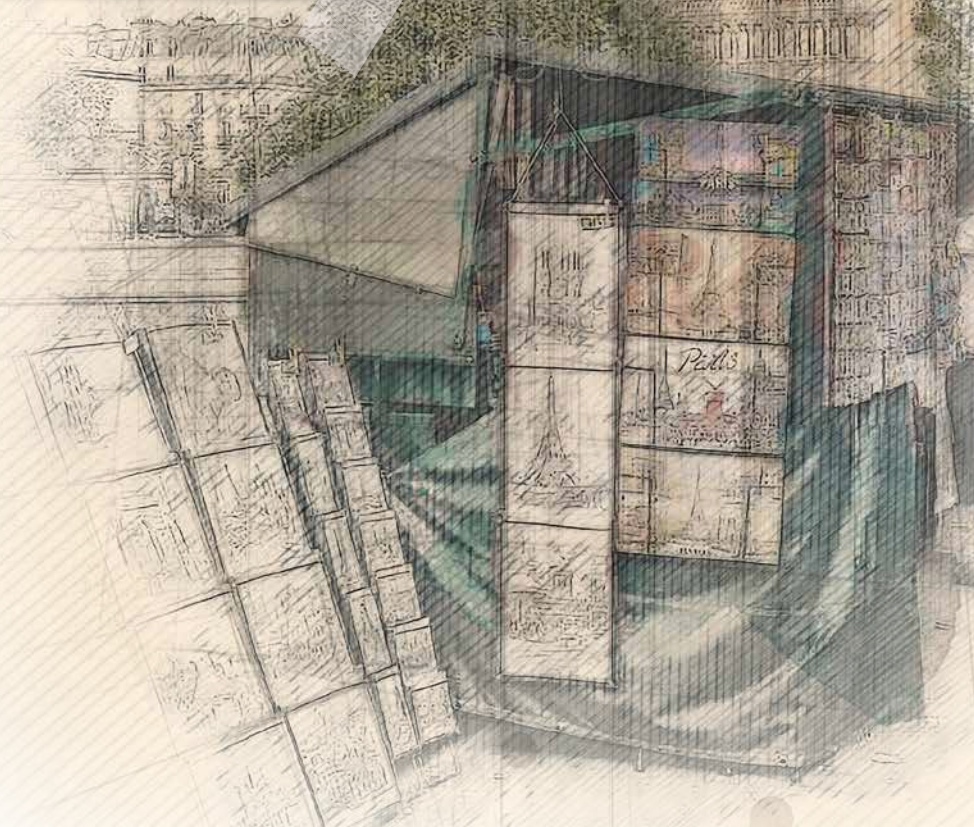





21

*Saint-Germain
à manettes / with lever handles*

Saint-Germain à manettes / with lever handles

22





F34 PVD couleur bronze brown mat - Matt brown bronze color PVD

Saint-Germain à manettes / with lever handles

24



G7D.151-504N-309/S-546-536

Ensemble mélangeur de lavabo avec vidage et accessoires coordonnés

Basin mixer set with waste and matching accessories



Saint-Germain à manettes / with lever handles

DES LIGNES GRAPHIQUES ET MÉTALLIQUES
EN HOMMAGE AU PARIS INDUSTRIEL

« Vous pouvez créer de la mode partout dans le monde, mais l'endroit où vous êtes couronné est Paris. » (Sonia Rykiel)

Cette salle de bain réunit tous les codes du style industriel grâce à une décoration aux formes graphiques jouant sur le contraste entre le noir et le blanc avec des équipements et accessoires imitant à merveille le fer forgé de nombreux monuments parisiens, et renforcé par une robinetterie Saint-Germain en PVD bronze brown mat, et un carrelage mural emblématique de celui du métro parisien.

La baignoire, les miroirs, les appliques et le carrelage instaillent une touche rétro à cet ensemble exprimant un style de vie parisien branché et contemporain.

GRAPHIC AND METALLIC LINES
IN HOMAGE TO PARIS INDUSTRIEL

"You can create fashion anywhere in the world, but the place where you are crowned is Paris." (Sonia Rykiel)

This bathroom combines all the codes of the industrial style thanks to a decoration with graphic forms playing on the contrast between black and white with equipment and accessories perfectly imitating the wrought iron of many Parisian monuments, and accentuated by a Saint-Germain tap in matt brown bronze PVD, and a wall tiling emblematic of the Parisian metro.

The bathtub, mirrors, sconces and tiles add a retro touch to this set, expressing a trendy and contemporary Parisian lifestyle.



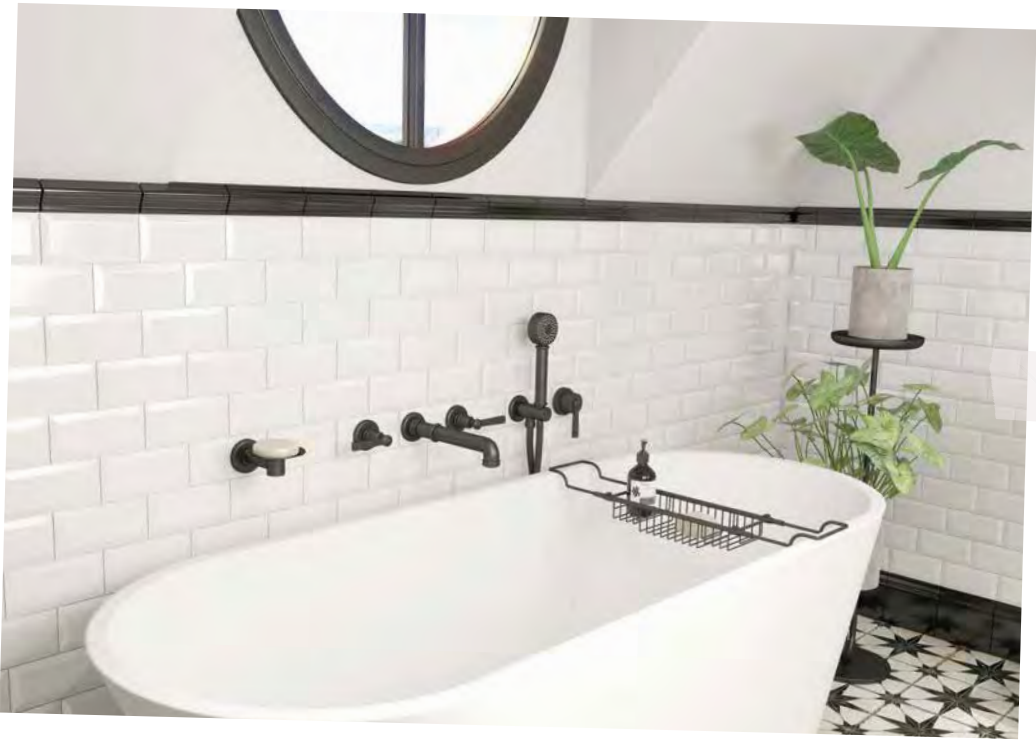

G7D.41SGB-40AM-6561B-5840/MA-546-622

Ensemble mélangeur de bain mural avec douchette, porte-savon et pont de baignoire
Wall mounted bath mixer set with handshower, soap dish and bath rack

Saint-Germain à manettes / with lever handles

28



G7D,5401BEH-5401AHM-54-83-281T-620-514VD

Ensemble de douche thermostatique avec pomme et douchette, porte-savon et porte-serviettes
Thermostatic shower set with shower head and handshower, soap dish and towel rail







Club Saint-Germain







G7H.151-504N-500-536-669R-710CL

Ensemble mélangeur de lavabo avec vidage et accessoires coordonnés
Basin mixer set with waste and matching accessories



LE DESIGN INTIMISTE DU PARIS ROMANTIQUE

« J'ai deux amours, mon pays et Paris,
par eux toujours mon cœur est ravi. »
(Joséphine Baker)

Capitale de l'amour par excellence, Paris est propice aux rêveries. C'est le Paris secret des ruelles, des galeries et des passages couverts, des jardins cachés derrière les portes cochères. C'est aussi la poésie des quais de Seine, les barques du Bois de Boulogne, les roses de Bagatelle. Rose, que ce soit la fleur ou la couleur, symbolise avant tout le romantisme et la séduction.

En duo avec des boiseries blanches au style haussmannien, le rose poudré apporte une touche raffinée à la pièce. À la fois chambre et salle de bain, c'est une invitation délicate à faire de ce lieu unique un espace de détente et de relaxation.

L'aspect chaleureux du bois et l'univers art déco avec ses meubles aux formes rectilignes et voluptueuses nous plongent dans le Paris d'Antan. L'époque des cabarets et des clubs de jazz dont le plus célèbre, ouvert en 1948 et animé par l'orchestre de Boris Vian, a inspiré le nom de cette nouvelle collection « Club Saint-Germain » avec un robinet au bec élané.

THE INTIMATE DESIGN OF PARIS ROMANTIQUE

"I have two loves, my country and Paris, by them my heart is always delighted."
(Joséphine Baker)

Capital of love "par excellence", Paris is conducive to daydreams. It is the secret Paris of alleys, galleries and covered passages, gardens hidden behind doors. It is also the poetry of the quays of the Seine, the boats of the Bois de Boulogne, the roses of Bagatelle. As these last ones, the pink colour symbolises above all romanticism and seduction.

In combination with white woodwork in the Haussmann style, powder pink brings a refined touch to the room. Both bedroom and bathroom, it is a delicate invitation to make this unique place a space of relaxation.

The warm look of wood on the floor and ceiling as well as the art deco universe with its straight and voluptuous furniture plunge us into the Paris of yesteryear. The era of cabarets and jazz clubs, the most famous of which, opened in 1948 and hosted by Boris Vian's orchestra, inspired the name of this new collection "Club Saint-Germain" with a high spout.

Club Saint-Germain





G7H.13CS-622

Mélangeur bain/douche sur colonne et pont de baignoire
Free-standing bath/shower mixer and bath rack





G7H.64TRCD-281R-3623-638V

Ensemble colonne de douche thermostatique
avec pomme et douchette, porte-savon et boutons de porte
Thermostatic shower column set
with shower head and handshower, soap dish and door knobs





G7H.5840/9-30B-30/HA-4720C-538AC-542-710CL-219D

Ensemble hygiénique, plaque de déclenchement et accessoires coordonnés
WC flush plate and matching accessories



G7H.TWT6H2

Sèche-serviettes Traditionnel
Traditional towel warmer





Club Saint-Germain
à manettes / with lever handles

Club Saint-Germain à manettes / with lever handles

42





Club Saint-Germain à manettes / with lever handles

44

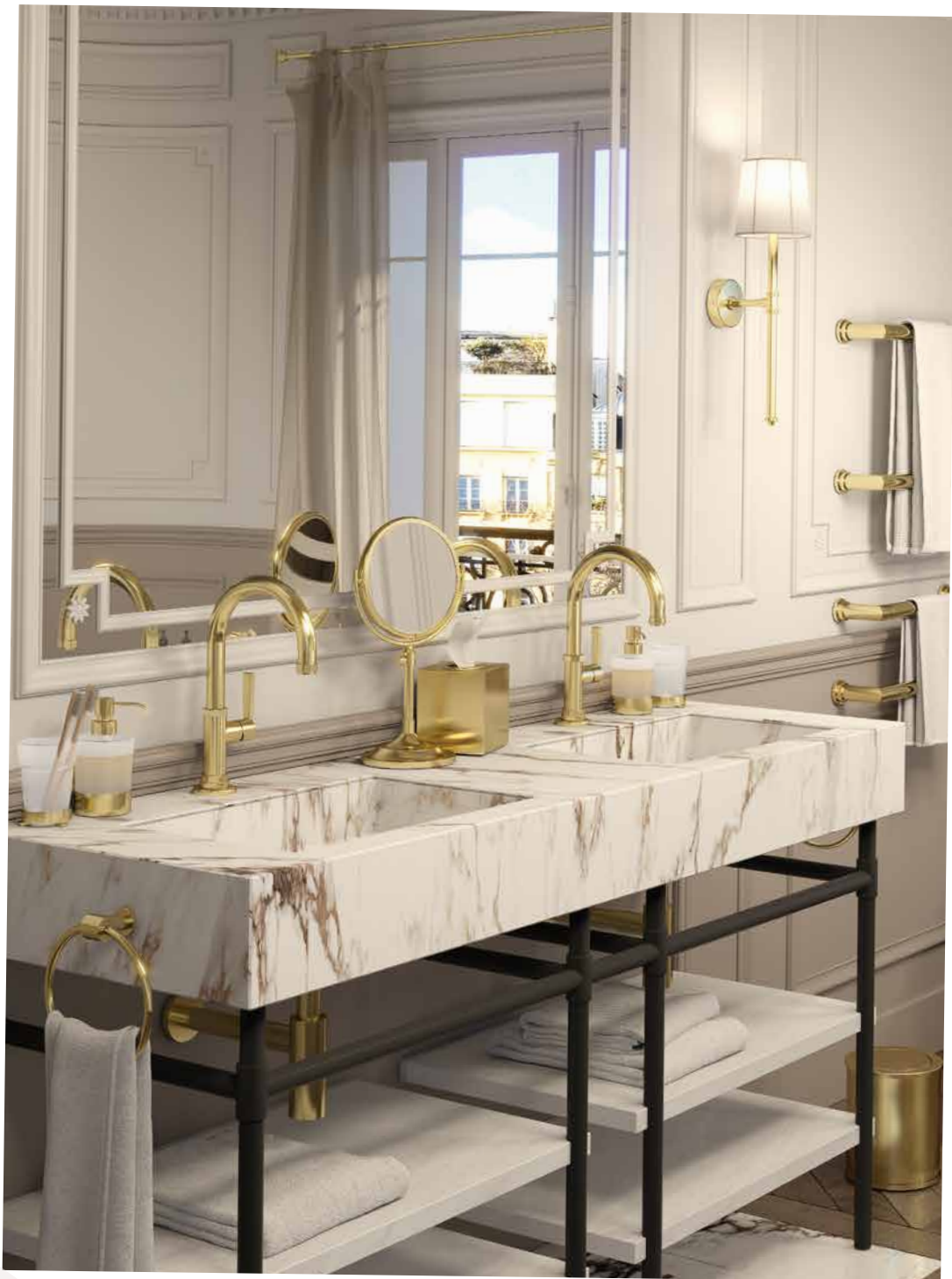

G7J.6500-613P-536P-2704-660-309/S-TWR1E

Ensemble mitigeur de lavabo avec vidage et accessoires coordonnés
Single lever basin mixer set with waste and matching accessories



Club Saint-Germain à manettes / with lever handles

LE STYLE MAJESTUEUX AUX DÉTAILS
SOIGNÉS DU PARIS HAUSSMANNIEN

« Ajoutez deux lettres à Paris :
c'est le paradis. » (Jules Renard)

Chaque élément du décor est un clin d'œil à la signature haussmannienne qui s'attache à mille-et-un détails : plafond haut, moulures en plâtre sur les murs mais aussi sur les portes, les miroirs et la baignoire, parquet en bois massif dit « point de Hongrie », marbre... Que serait Paris sans les travaux du Baron Haussmann ? Héritages du Second Empire, ses immeubles imposent les codes d'une esthétique urbaine au cachet inégalé : un style chic renforcé ici par la finition or pâle de la robinetterie et des accessoires. Cette salle de bain reflète la Ville Lumière par son caractère flamboyant et la splendeur de ses éléments. Elle fait assurément de Paris la capitale du luxe !

THE MAJESTIC STYLE WITH NEAT
DETAILS OF PARIS HAUSSMANNIEN

"Add two letters to Paris: it's paradise."
(Jules Renard)

Each element of the decor is a nod to the Haussmannian signature, which is attached to a thousand-and-one details: high ceiling, plaster mouldings on the walls, but also on the doors, mirrors and bathtub, solid wood flooring called "point de Hongrie", marble... What would Paris be without the work of Baron Haussmann? Inherited from the Second Empire, its buildings impose the codes of an urban aesthetic with an unequalled character: a chic style accentuated here by the soft gold finish of the fittings and accessories. This bathroom reflects the City of Light through its flamboyant character and the splendour of its elements. It certainly makes Paris the capital of luxury!

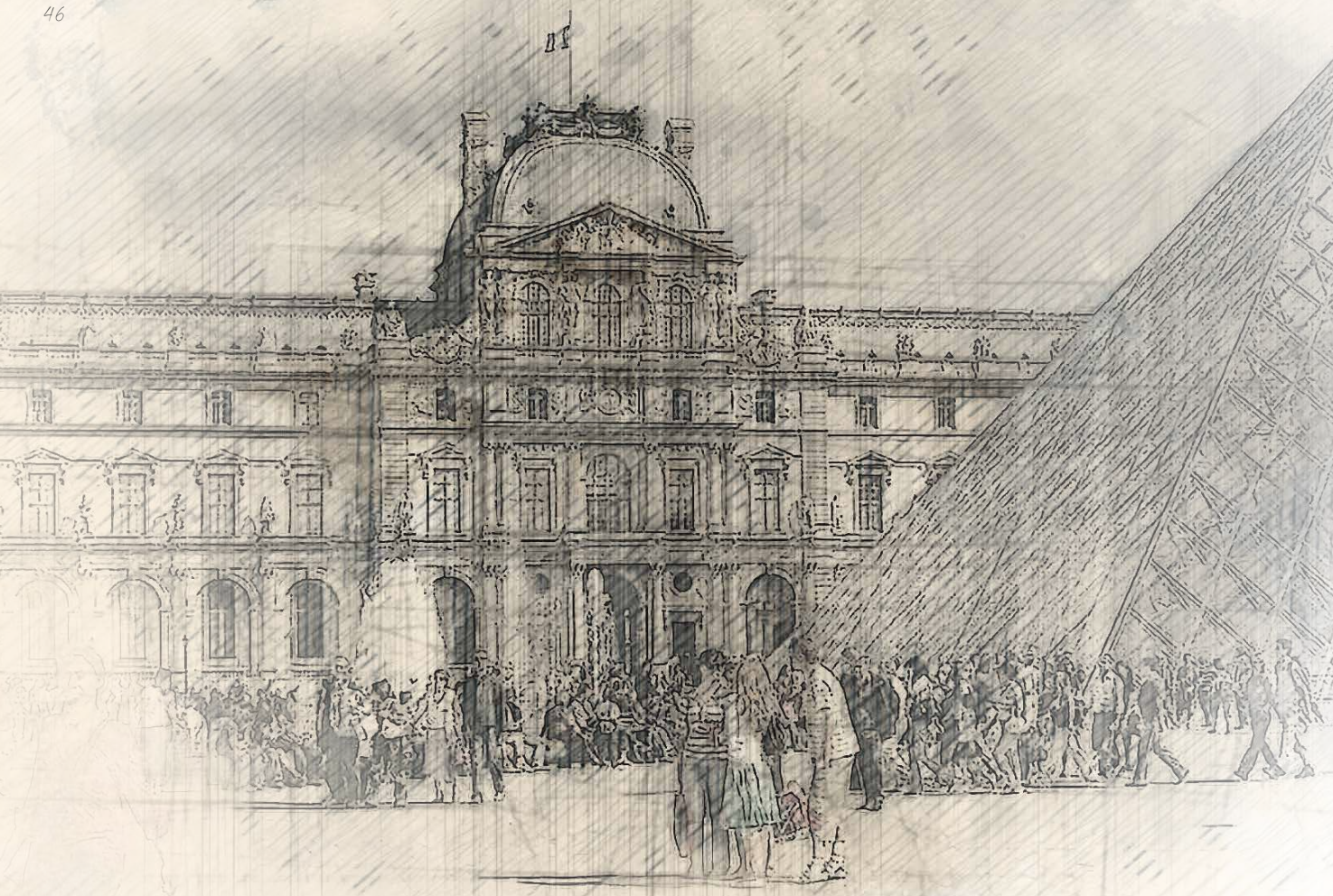

G7J,5100BR-5200AE-30B-30/HA-54-209/B-491

Ensemble de douche thermostatique avec douchette et plafond de douche, jets latéraux
Thermostatic shower set with handshower and sky shower, body jets

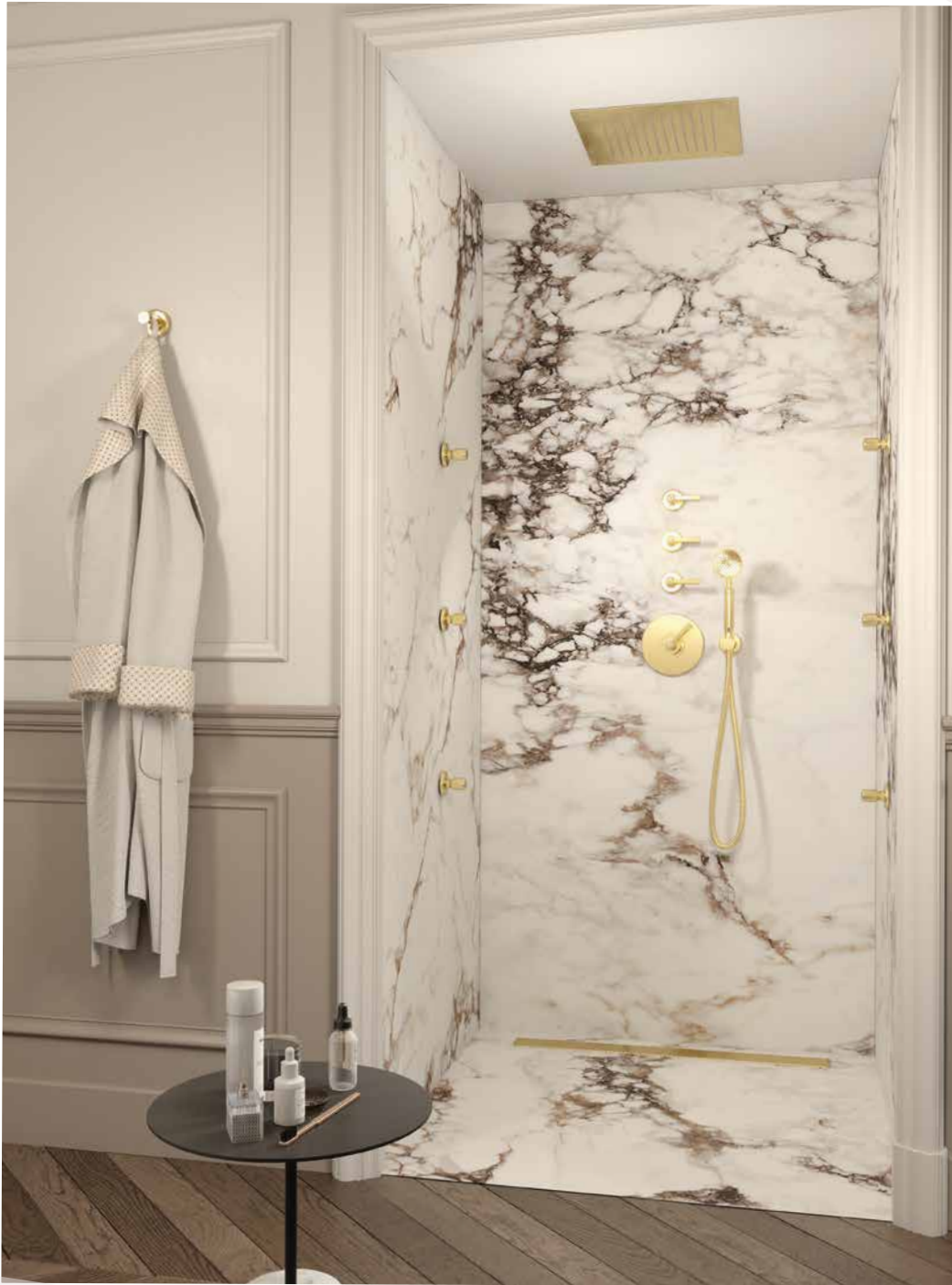

Club Saint-Germain à manettes / with lever handles



G7H.3202-5840/8-504N

Mélangeur de bidet avec vidage
et ensemble hygiénique

Bidet mixer with waste and WC douchet set

48



G7J.1132SG

Mélangeur de bain et douchette alimentée par mitigeur

Bath mixer and handshower supplied by progressive cartridge mixer



B6B.TWR1E

Sèche-serviette 1 barre, électrique
Towel warmer 1 rail, electric

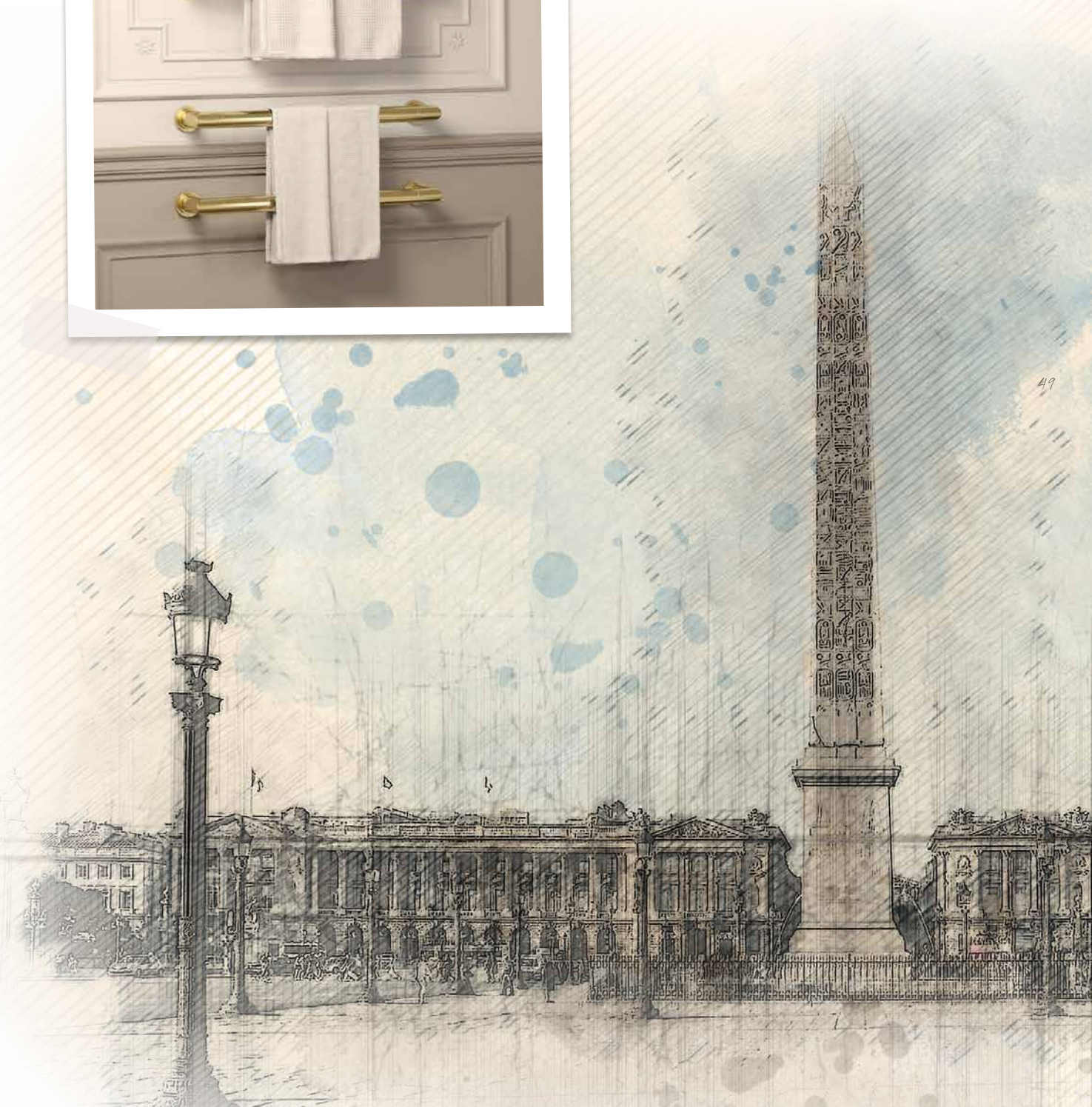





51

Saint-Germain
cuisine / kitchen

Saint-Germain cuisine / kitchen

LA CUISINE SE MET AU VERT : UN STYLE ASSUMÉ

« Respirer Paris, cela conserve l'âme. » (Victor Hugo)

La collection Saint-Germain s'invite aussi dans la cuisine. Son design brut vintage, héritage des usines et des ateliers français, apporte sobriété et simplicité à une décoration contemporaine.

Pour donner de la personnalité à la pièce, on joue sur les contrastes. Les finitions dorées ou foncées mates de la robinetterie mais aussi des poignées de meubles se marient avec la douceur du vert sauge et du plan de travail en marbre. L'esthétisme s'associe à une fonctionnalité professionnelle avec le mitigeur et la douchette assurant un confort optimal.

THE KITCHEN GOES GREEN: AN ASSERTIVE STYLE

"Breathing in Paris keeps the soul alive." (Victor Hugo)

The Saint-Germain collection also invites itself into the kitchen. Its raw vintage design, a legacy of French factories and workshops, brings sobriety and simplicity to a contemporary decor.

To give personality to the room, we play on contrasts. The golden or dark matt finishes of the taps and the handles of the furniture blend with the softness of the sage-green and the marble worktop. Aesthetics is combined with professional functionality with the sink mixer and hand shower ensuring optimal comfort.

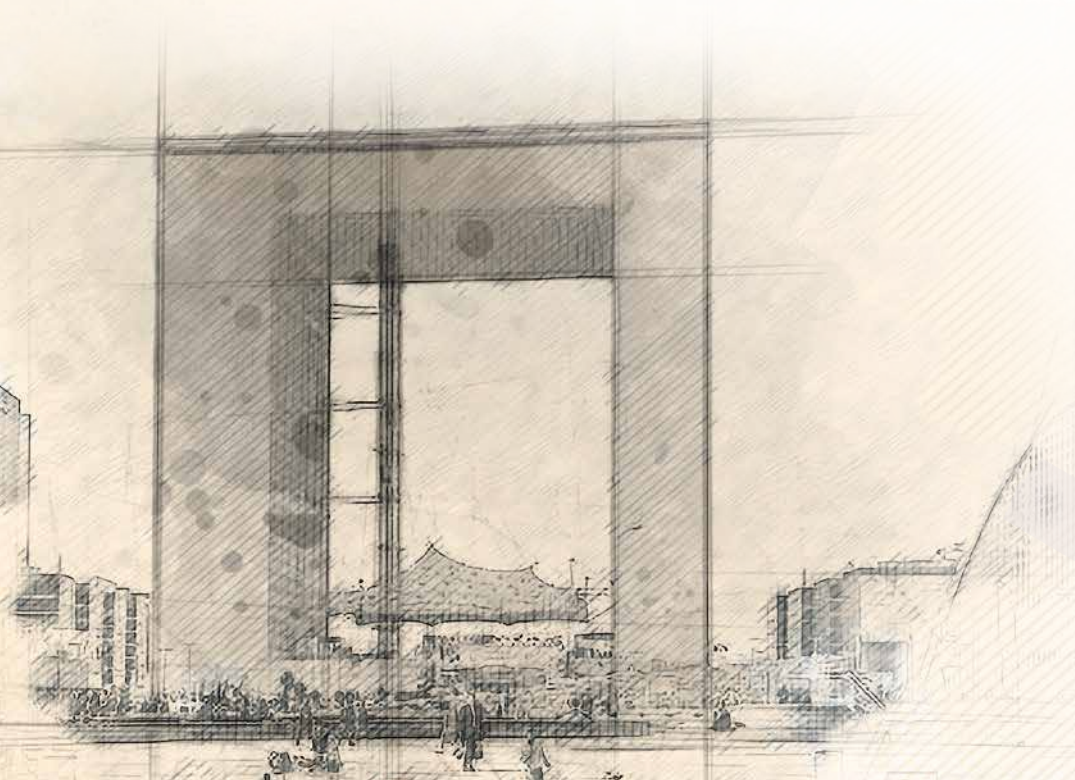



53

G7C.6181N-613E

Mitigeur d'évier et distributeur de savon

Single lever sink mixer and built-it soap dispenser

SOLUTIONS, ENSEMBLES ET PRODUITS ASSOCIÉS G7C & G7D
SOLUTIONS, PACKAGES AND ASSOCIATED PRODUCTS G7C & G7D

ENSEMBLE DES COLLECTIONS | COLLECTION DETAILS



G7C SAINT-GERMAIN



G7D SAINT-GERMAIN À MANETTES
with lever handles

SOLUTIONS, ENSEMBLES ET PRODUITS ASSOCIÉS G7C & G7D
SOLUTIONS, PACKAGES AND ASSOCIATED PRODUCTS G7C & G7D

LAVABO | BASINS



151
Mélangeur de lavabo avec vidage
Basin mixer with waste



40GB+40AC
Ensemble mélangeur de
lavabo mural
Wall mounted basin mixer set



6541B+5840/MA
Ensemble mitigeur de lavabo mural
Wall mounted basin mixer set



6500
Mitigeur de lavabo avec vidage
Single lever basin mixer with waste



6506H
Mitigeur de lavabo sans vidage
Single lever basin mixer without
waste



22GAB-6702R
Ensemble mitigeur de lavabo mural
infrarouge
Wall mounted basin mixer
with infrared trigger cell



170IRS
Bec de lavabo infrarouge
Infrared basin spout



6500S
Mitigeur de lavabo sur colonne
Free-standing basin mixer

SOLUTIONS, ENSEMBLES ET PRODUITS ASSOCIÉS G7C & G7D
SOLUTIONS, PACKAGES AND ASSOCIATED PRODUCTS G7C & G7D

BAIN | BATH

Saint-Germain

56



1132SG

Mélangeur de bain et douchette alimentée par mitigeur
Bath mixer and handshower supplied by mixer



41GB - 40AC - 6561B- 5840/MA

Ensemble mélangeur de bain mural
avec douchette alimentée par mitigeur
Wall mounted bath mixer with handshower
supplied by mixer



6508S

Mitigeur bain/douche sur colonne
Free-standing bath/shower mixer

SOLUTIONS, ENSEMBLES ET PRODUITS ASSOCIÉS G7C & G7D
SOLUTIONS, PACKAGES AND ASSOCIATED PRODUCTS G7C & G7D

BAIN | BATH



1132SG
 Mélangeur de bain et douchette
 alimentée par mitigeur
 Bath mixer and handshower
 supplied by mixer



255G
 Mélangeur de bain
 Bath mixer

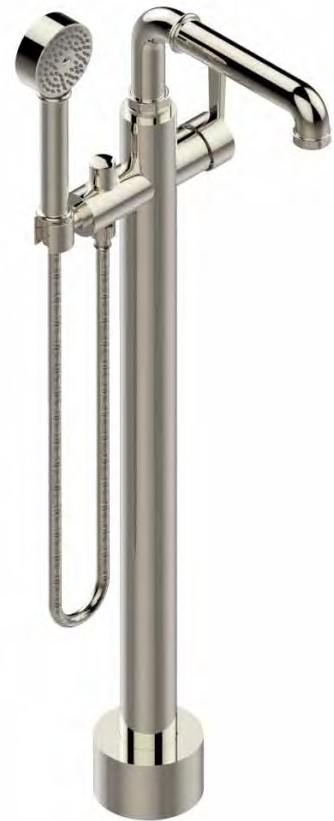

6508S
 Mitigeur bain/douche sur colonne
 Free-standing bath/shower mixer



41GB+40AC
 Ensemble mélangeur de bain mural
 Wall mounted bath mixer set



6561B+5840/MA
 Ensemble douchette murale
 alimentée par mitigeur
 Wall mounted handshower set
 supplied by mixer



SOLUTIONS, ENSEMBLES ET PRODUITS ASSOCIÉS G7C & G7D
SOLUTIONS, PACKAGES AND ASSOCIATED PRODUCTS G7C & G7D

CUISINE | KITCHEN



159DM
Mélangeur d'évier 3 trous avec
douchette individuelle
3-hole sink mixer with side spray



4211
Mélangeur d'évier 4 trous avec
douchette individuelle
4-hole sink mixer with side spray



6181N
Mitigeur d'évier
Single lever sink mixer



6181D
Mitigeur d'évier avec douchette
extractible
Single lever sink mixer with pull-out
spray



6181N/D
Mitigeur d'évier avec douchette
individuelle
Single lever sink mixer with side
spray



6506H
Mitigeur d'évier
Single lever bar mixer tap



613E
Distributeur de savon encastrable
Built-in soap dispenser





SOLUTIONS, ENSEMBLES ET PRODUITS ASSOCIÉS G7H & G7J
SOLUTIONS, PACKAGES AND ASSOCIATED PRODUCTS G7H & G7J

ENSEMBLE DES COLLECTIONS | COLLECTION DETAILS



G7H CLUB SAINT-GERMAIN



G7J CLUB SAINT-GERMAIN À MANETTES
with lever handles

SOLUTIONS, ENSEMBLES ET PRODUITS ASSOCIÉS G7H & G7J
SOLUTIONS, PACKAGES AND ASSOCIATED PRODUCTS G7H & G7J

LAVABO | BASINS



151

Mélangeur de lavabo avec vidage
Basin mixer with waste



40GB+40AC

Ensemble mélangeur de
lavabo mural
Wall mounted basin mixer



6541B+5840/MA

Ensemble mitigeur de lavabo mural
Wall mounted basin mixer set



6500

Mitigeur de lavabo avec vidage
Single lever basin mixer with waste



170IRS

Bec de lavabo infrarouge
Infrared basin spout



22GAB-6702R

Ensemble mitigeur de lavabo mural
infrarouge
Wall mounted basin mixer
with infrared trigger cell

SOLUTIONS, ENSEMBLES ET PRODUITS ASSOCIÉS G7H & G7J
SOLUTIONS, PACKAGES AND ASSOCIATED PRODUCTS G7H & G7J

BAIN | BATH



112BSG

Mélangeur de bain avec douchette
Bath mixer with handshower



41GB - 40AC - 6561B- 5840/MA

Ensemble mélangeur de bain mural
avec douchette alimentée par mitigeur
Wall mounted bath mixer with handshower supplied by mixer



13CS-13800A

Mélangeur bain/douche sur colonnes
Free-standing bath/shower mixer



6508S

Mitigeur bain/douche sur colonne
Free-standing bath/shower mixer

SOLUTIONS, ENSEMBLES ET PRODUITS ASSOCIÉS G7H & G7J
SOLUTIONS, PACKAGES AND ASSOCIATED PRODUCTS G7H & G7J

BAIN | BATH



112BSG
 Mélangeur de bain avec douchette
 Bath mixer with handshower



13CS+13800A
 Mélangeur bain/douche sur colonne
 Free-standing bath/shower mixer



6508S
 Mitigeur bain/douche sur colonne
 Free-standing bath/shower mixer



25SG
 Mélangeur de bain
 Bath mixer



41GB+40AC
 Ensemble mélangeur de bain mural
 Wall mounted bath mixer set



6561B+5840/MA
 Ensemble douchette murale
 alimentée par mitigeur
 Wall mounted handshower set
 supplied by mixer

SOLUTIONS, ENSEMBLES ET PRODUITS ASSOCIÉS G7H & G7J
SOLUTIONS, PACKAGES AND ASSOCIATED PRODUCTS G7H & G7J

CUISINE | KITCHEN



159DM
Mélangeur d'évier 3 trous avec
douchette individuelle
3-hole sink mixer with side spray



4211
Mélangeur d'évier 4 trous avec
douchette individuelle
4-hole sink mixer with side spray



6181N
Mitigeur d'évier
Single lever sink mixer



6181D
Mitigeur d'évier avec douchette
extractible
Single lever sink mixer with pull-out
spray



6181N/D
Mitigeur d'évier avec douchette
individuelle
Single lever sink mixer with side
spray



SOLUTIONS, ENSEMBLES ET PRODUITS ASSOCIÉS G7C, G7D, G7H & G7J
SOLUTIONS, PACKAGES AND ASSOCIATED PRODUCTS G7C, G7D, G7H & G7J

DOUCHE | SHOWER

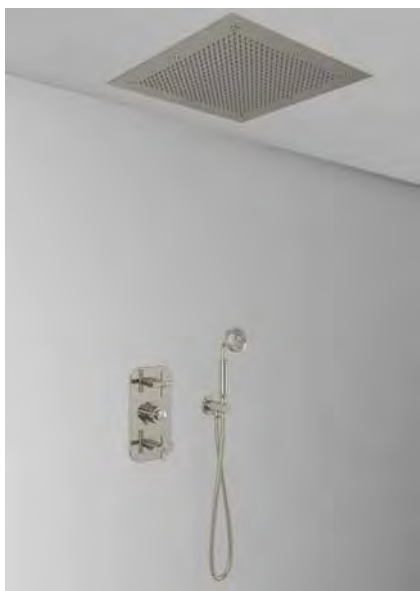

5400BE - 5400AE - 54 - 487

Ensemble douche thermostatique 2 fonctions :
plafond de douche et douchette
Thermostatic shower set 2 functions: sky shower and
handshower



64TRCD - 281R

Ensemble douche thermostatique avec colonne,
2 fonctions : pomme et douchette
Thermostatic shower set 2 functions with shower
column, shower head and handshower

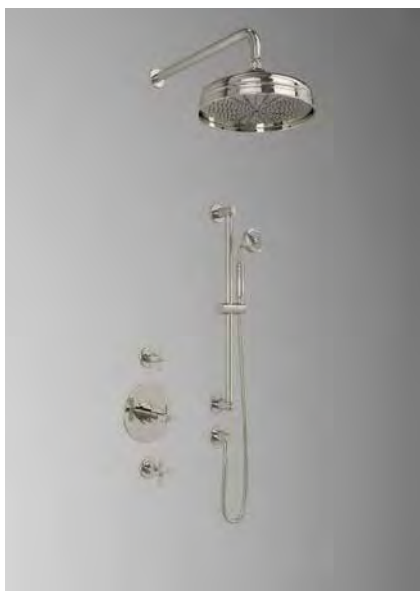

**5100BR - 5200AE - 2X30B - 2X30/HA - 58 -
84L - 280R**

Ensemble douche thermostatique 2 fonctions :
pomme et douchette sur barre
Thermostatic shower set 2 functions: shower head
and handshower on slidebar

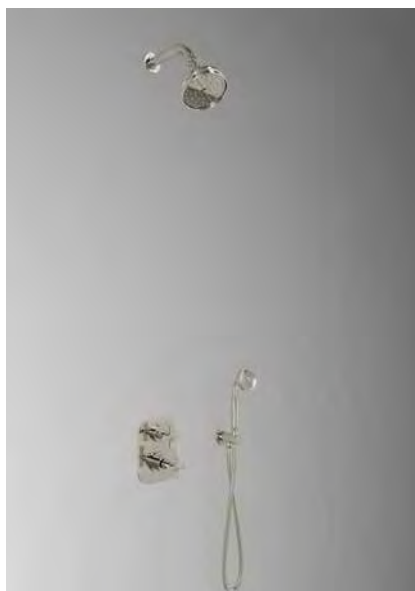

5500BE - 5500AE - 54 - 84 - 187

Ensemble douche thermostatique 2 fonctions :
pomme et douchette
Thermostatic shower set 2 functions: shower head
and handshower

SOLUTIONS, ENSEMBLES ET PRODUITS ASSOCIÉS G7C, G7D, G7H & G7J
SOLUTIONS, PACKAGES AND ASSOCIATED PRODUCTS G7C, G7D, G7H & G7J

DOUCHE | SHOWER

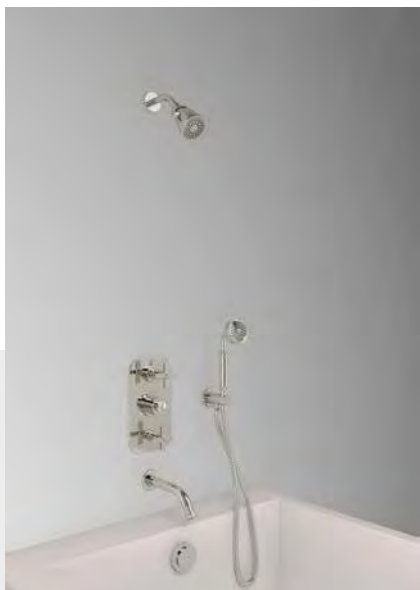

5540BE - 5540AE - 42GB - 54 - 82 - 288L

Ensemble bain/douche thermostatique 3 fonctions :
 pomme, douchette et bain
 Thermostatic bath/shower set 3 functions: shower
 head, handshower and bath

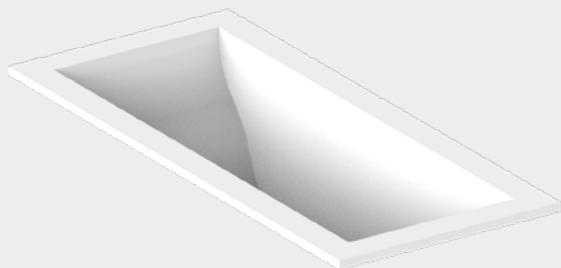

B10.B500 ASTRELLE 180 x 80 x 65cm

Baignoire à encastrer
 Built-in bathtub



302GM

Vidage de baignoire
 Bath waste



Saint-Germain



Club Saint-Germain

La douchette est différente pour
 Saint-Germain et Club Saint-Germain

Handshower is different for
 Saint-Germain and Club Saint-Germain

SOLUTIONS, ENSEMBLES ET PRODUITS ASSOCIÉS G7C, G7D, G7H & G7J
SOLUTIONS, PACKAGES AND ASSOCIATED PRODUCTS G7C, G7D, G7H & G7J

DOUCHE | SHOWER



5400BE+5400AE
 Ensemble thermostatique
 avec 2 robinets d'arrêt
 THG thermostat set
 with 2 valves



5500BE+5500AE
 Ensemble thermostatique
 avec inverseur 2 sorties
 THG thermostat set
 with 2-way diverter



5540BE+5540AE
 Ensemble thermostatique
 3 fonctions
 THG thermostat set
 with 3 functions



5100BR+5200AE
 Ensemble thermostatique
 THG thermostat set



30B+30/HA
 Robinet d'arrêt 1/2"
 Wall valve 1/2"



5100B+5200AE
 Ensemble thermostatique
 THG thermostat set



290/B
 Jet latéral avec buses -
 système Easyclean
 Body jet with Easyclean
 system



58
 Ensemble douchette
 avec barre
 Handshower set with
 slidebar



64TRCD
 Mitigeur thermostatique de
 douche avec colonne
 et douchette, pomme de
 douche vendue séparément
 Thermostatic shower mixer
 with shower column and
 handshower, showerhead
 sold separately



54
 Ensemble douchette
 Saint-Germain
 Saint-Germain
 Handshower set

54
 Ensemble douchette
 Club Saint-Germain
 Club Saint-Germain
 Handshower set

SOLUTIONS, ENSEMBLES ET PRODUITS ASSOCIÉS G7C, G7D, G7H & G7J
SOLUTIONS, PACKAGES AND ASSOCIATED PRODUCTS G7C, G7D, G7H & G7J

DOUCHE | SHOWER



82
 Bras pour pomme de
 douche long. 120 mm, 45°
 Wall mounted shower
 arm, length: 120mm, 45°



84
 Bras pour pomme de
 douche long. 250 mm
 Wall mounted shower
 arm, length: 250mm



84L
 Bras pour pomme de
 douche long. 450 mm
 Wall mounted shower
 arm, length: 450mm



82V
 Bras vertical pour pomme
 de douche
 Vertical shower arm



281R
 Pomme de douche Ø 220
 mm, système Easyclean
 Shower head Ø 220mm,
 Easyclean system



288L
 Pomme de douche Ø
 70 mm à débit variable,
 système Easyclean
 Adjustable shower head
 Ø 70mm, Easyclean system



187
 Pomme de douche Ø 120
 mm, système Easyclean
 Shower head Ø 120mm,
 Easyclean system



281T
 Pomme de douche Ø 220
 mm, système Easyclean
 Shower head Ø 220mm,
 Easyclean system



281EP
 Pomme de douche Ø 200
 mm, système Easyclean
 Shower head Ø 200mm,
 Easyclean system



494
 Plafond de douche inox
 Ø 380 mm
 Metal sky shower
 Ø 380mm



487
 Plafond de douche
 454 x 454 mm, avec
 système Easyclean
 Sky shower 454x454mm,
 Easyclean system



492
 Plafond de douche inox
 chromothérapie avec lames
 d'eau, 700 x 380 mm
 Stainless steel
 chromotherapy Sky
 shower with water blade,
 700x380mm

SOLUTIONS, ENSEMBLES ET PRODUITS ASSOCIÉS G7C, G7D, G7H & G7J
SOLUTIONS, PACKAGES AND ASSOCIATED PRODUCTS G7C, G7D, G7H & G7J

BIDET WC | BIDET WC



5840/MBG+5840/MA

Ensemble hygiénique alimenté par mitigeur
WC douche set with single lever mixer



5840/9

Ensemble hygiénique
WC douche set



3202

Mélangeur de bidet avec vidage
Bidet mixer with waste



219SC / 219TC

Plaque de déclenchement WC compatible GEBERIT / compatible TECE
GEBERIT compatible / TECE compatible WC Flush plate

BOUTONS ET POIGNÉES | HARDWARE



638V

Paire de boutons de porte
Pair of door knobs



514VD

Paire de porte-serviette pour porte en verre
Double towel rail, to be installed in a glass door back to back



514V2

Porte-serviette pour porte en verre avec bouton
Towel rail for glass door with door knob

SOLUTIONS, ENSEMBLES ET PRODUITS ASSOCIÉS G7C, G7D, G7H & G7J
SOLUTIONS, PACKAGES AND ASSOCIATED PRODUCTS G7C, G7D, G7H & G7J

ACCESSOIRES | ACCESSORIES



504N
 Anneau porte-serviette
 Towel ring



517
 Porte-peignoir
 Robe hook



510
 Porte-peignoir
 Robe hook



520/30 - 520/45 - 520/60
 Porte-serviette,
 longueur 30,45,60 cm
 Single towel rail,
 length 30,45,60cm



4RACK2
 Porte-serviettes
 Towel rail and rack



10C
 Porte-serviettes
 Towel stand



613
 Distributeur de savon
 mural
 Wall mounted soap
 dispenser



613P
 Distributeur de savon
 Soap dispenser



536
 Porte-verre mural
 Wall mounted tumbler



536P
 Porte-verre à poser
 Tumbler and holder on
 stand



544
 Coupe porte-savon
 Soap dish



546
 Porte-savon mural
 Wall mounted soap dish

SOLUTIONS, ENSEMBLES ET PRODUITS ASSOCIÉS G7C, G7D, G7H & G7J
SOLUTIONS, PACKAGES AND ASSOCIATED PRODUCTS G7C, G7D, G7H & G7J

ACCESSOIRES | ACCESSORIES



2704
Boîte à mouchoirs
Tissue box



660
Miroir à poser double face
Free-standing mirror, reversible



668
Miroir mural grossissant
Wall mounted magnifying mirror



669R
Miroir mural grossissant éclairage LED
Wall mounted magnifying led illuminated mirror



710CL
Corbeille à pédale
Waste bin with lid and pedal



711CL
Corbeille à couvercle basculant
Waste bin with tilting lid

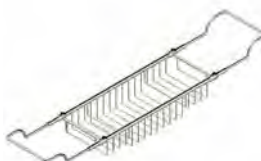

622
Pont de baignoire
Bath rack



3623
Porte-savon fil
Net soap dish



620
Porte-savon fil mural
Net soap dish with flange



538AC
Porte-papier
WC paper holder



542
Porte-papier rouleau de réserve
Wall mounted WC reserve paper holder



4720C
Ensemble pot à balai mural
Wall mounted WC brush holder

SOLUTIONS, ENSEMBLES ET PRODUITS ASSOCIÉS G7C, G7D, G7H & G7J
SOLUTIONS, PACKAGES AND ASSOCIATED PRODUCTS G7C, G7D, G7H & G7J

SÈCHE-SERVIETTES | TOWEL WARMERS



TWT8H2

Sèche-serviettes 8 barres, hydraulique,
avec 2 croisillons de style
Towel warmer 8 rails, hydronic, with 2 stylised handles



TWR4H2

Sèche-serviettes 4 barres, hydraulique,
avec 2 croisillons de style
Towel warmer 4 rails, hydronic, with 2 stylised handles



B6B.TWR1E

Sèche-serviette 1 barre, électrique
Towel warmer 1 rail, electric



Téléchargez tous nos catalogues sur notre site internet
Download all our catalogues on our website

WWW.THG-PARIS.COM

SOLUTIONS, ENSEMBLES ET PRODUITS ASSOCIÉS
SOLUTIONS, PACKAGES AND ASSOCIATED PRODUCTS

BAIGNOIRES ET VASQUES | BATHTUBS AND BASINS



B11.B692 HONORE
 Baignoire à poser
 Free-standing bathtub



B11.B591 MONCEAU
 Baignoire à poser
 Free-standing bathtub



B10.B520 CLARA
 Baignoire à encastrer
 Built-in bathtub

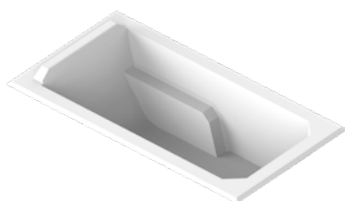

B10.B511 MELRIDGE
 Baignoire à encastrer
 Built-in bathtub



B10.B580 MONACO
 Baignoire à encastrer
 Built-in bathtub



B13.V540 CARLA
 Vasque à encastrer
 Under counter basin



B13.V590 MONCEAU
 Vasque à poser
 On counter basin



GB2.11/BP
 Vasque métal martelé
 Hammered metal basin



GB2.4/BP
 Vasque métal martelé
 Hammered metal basin

Retrouvez nos sanitaires, leurs accessoires et toutes les possibilités de personnalisation dans notre Cahier Technique Collections Bain.

Find our sanitaryware, their accessories and all customisation possibilities in our Sanitaryware Technical Specifications book.

Téléchargez tous nos catalogues sur notre site internet | Download all our catalogues on our website

WWW.THG-PARIS.COM



FINITIONS FINISHES

Plus de finitions disponibles sur WWW.THG-PARIS.COM

For more finishes and additional information, please visit WWW.THG-PARIS.COM

TRAITEMENTS CLASSIQUES | STANDARD TREATMENTS



A02
Chrome
Polished chrome



B01
Nickel
Polished nickel



C01
Nickel mat
Matt nickel



H03
Vieil argent
verniss brillant
Lacquered
antique silver



F30
Or pâle
Soft gold



F31
Or pâle mat
Soft matt gold



F01
Doré
Polished gold



F07
Doré mat
Matt gold



D01
Bronze clair
verniss brillant
Lacquered
light bronze



D05
Bronze clair
verniss mat
Lacquered
matt bronze

TRAITEMENTS PVD | PVD TREATMENTS



H55
PVD nickel
Nickel PVD



H56
PVD nickel mat
Matt nickel PVD



H64
PVD graphite
Graphite PVD



H65
PVD graphite mat
Matt graphite PVD



H49
PVD laiton
Brass PVD



H50
PVD laiton mat
Matt brass PVD



H52
PVD doré
Gold PVD



H53
PVD doré mat
Matt gold PVD



H66
PVD umber
Umbre PVD



H67
PVD umber mat
Matt umbre PVD



H62
PVD blush
Blush PVD



H60
PVD blush mat
Matt blush PVD



F33
PVD bronze brown
Bronze brown PVD



F34
PVD bronze brown mat
Matt brown
bronze PVD

CONTACT

SIÈGE SOCIAL

HEAD OFFICE

THG FRANCE

35, rue Tournière - BP 80212
Béthencourt-sur-Mer
80535 Friville cedex - France
+33 (0)3 22 60 20 80
contact@thg.fr
www.thg-paris.com

FILIALES

SUBSIDIARIES

THG USA LLC

Head office
441 NW - 1st avenue
Fort Lauderdale
FL 33301 - USA
Tel. +1 954 425 8225
info@thgusa.com

THG ASIA

7/F Building 11, Phase II
Zhong Jun Plaza,
1688 Shenchang Road,
Minhang District,
Shanghai - PRC
上海市闵行区申长路
1688弄中骏广场二期11号楼7楼
电话/Tel. +86 (21) 613 527 38
contact@thg-asia.cn

THG UK

11 Commercial Way,
London NW10 7XF
United Kingdom
Tel. +44 (0)20 8202 8288
salesuk@thg-paris.com

THG RUSSIA

Leningradskiy avenue,
bld. 37A, housing 14
125167 Moscow - Russia
Tel. +7 495 800 8225
thg@thg-russia.ru

SHOWROOMS THG

THG SHOWROOMS

PARIS

152 bd Haussmann
75008 Paris - France
Tel. +33 (0)1 44 20 09 20
info@delepine.com
www.delepine.com

NEW YORK

D&D Building
Showroom 1206 - 12th floor
979 Third Avenue - New-York
NY 10022 - USA
Tel. +1 (917) 242 8911
info@thgusa.com

DUBAI

Dubai Design District
Building 1, Office A404
Dubai - UAE
Tel. +971 4 375 4610
contact.me@thg-paris.com

LONDON

4 Pont Street
London SW1X 9EL
United Kingdom
Tel. +44 (0)20 7838 7788
salesuk@thg-paris.com
london.thg-paris.com

FRANKFURT

Gutleutstr. 96
60329 Frankfurt/Main
Deutschland
Tel. +49 (0)69/ 25 78 14 33
info@thg-deutschland.de



Entreprise
du Patrimoine
Vivant
L'excellence
des savoir-faire
français



CRÉDITS

CREDITS

CONCEPTION ET RÉALISATION

THG Paris

IMPRESSION

Imprimerie Jean Bernard

Textes et photos non contractuels et susceptibles
d'être modifiés sans préavis

Text and pictures are not binding and can be
modified without any previous notice

THG[®]
PARIS

WWW.THG-PARIS.COM